

Gene Chittick



patrol squadron forty-five
july 1976 - may 1977



Full
6

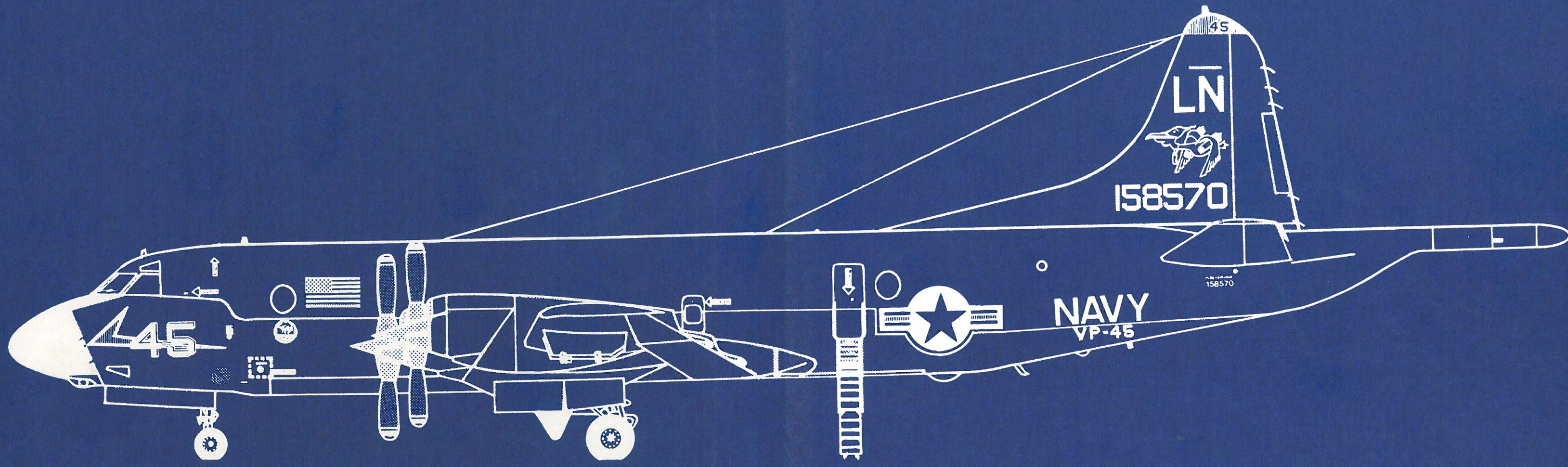

6 full

AWL
Gene Chittick

PATROL SQUADRON FORTY-FIVE

JULY 1976-MAY 1977



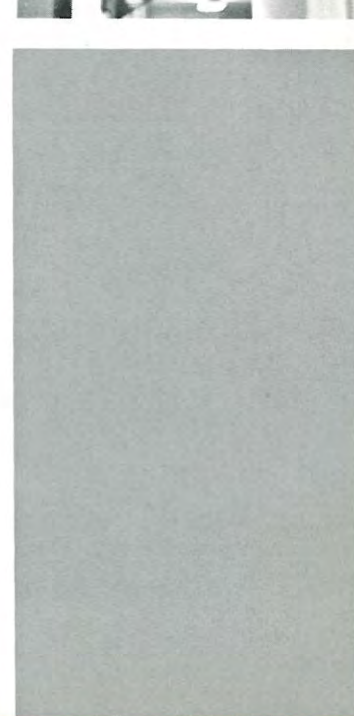
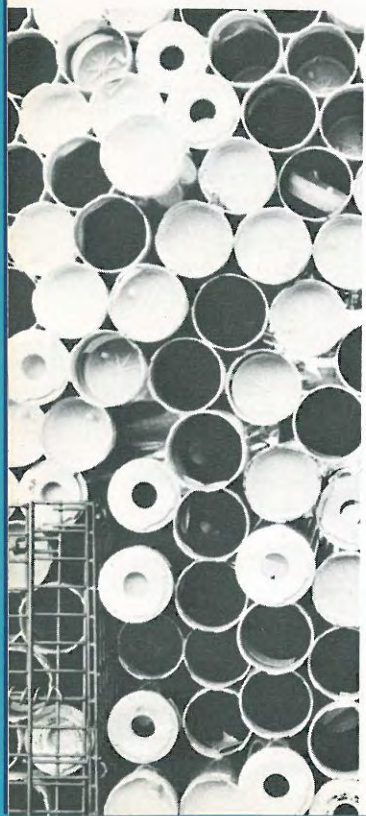
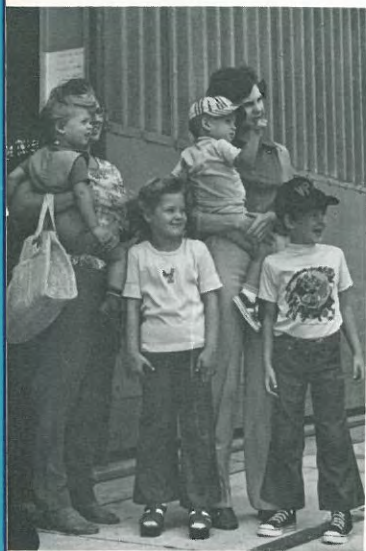
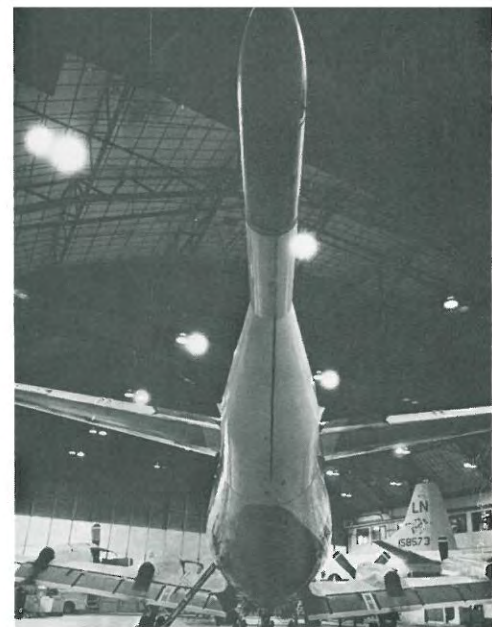
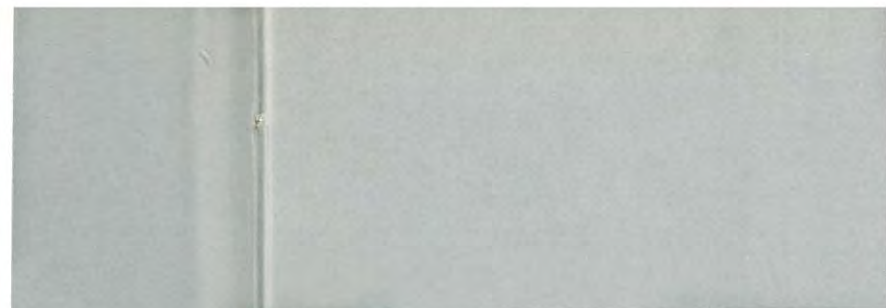
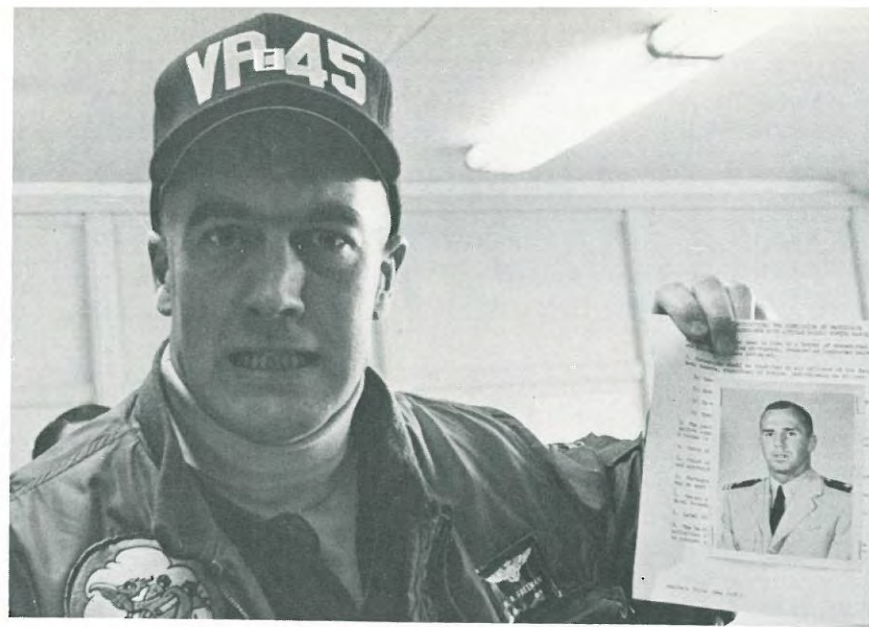
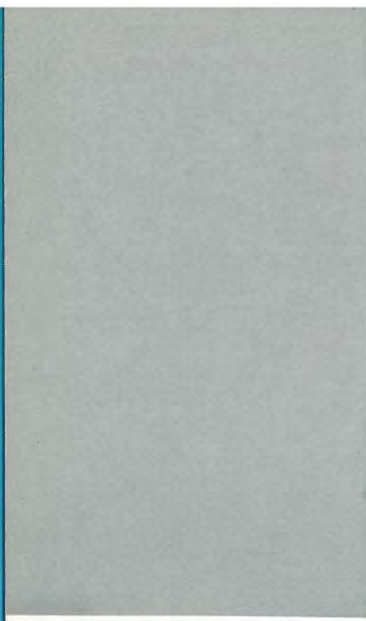

COMMANDING OFFICER
CDR STEPHEN F. LOFTUS, USN



EXECUTIVE OFFICER
CDR CHARLES J. McKINNEY, JR, USN

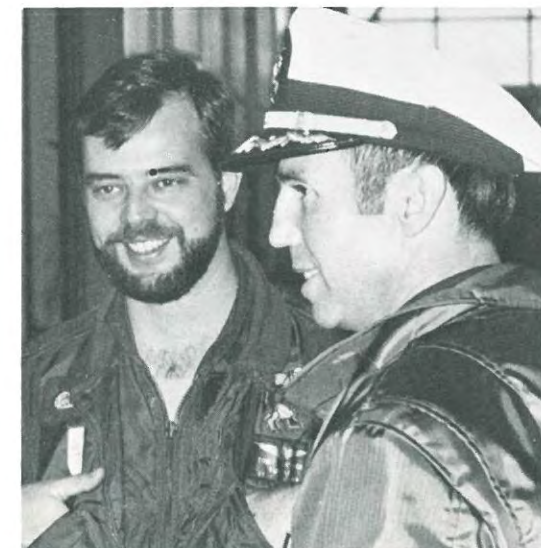

UNITAS XVII

UNITAS IS THE ANNUAL U.S.—SOUTH AMERICAN JOINT NAVAL EXERCISE HELD IN THE SUMMER AND FALL. IN THE BICENTENNIAL YEAR, VP-45 WAS SELECTED TO REPRESENT THE PATROL COMMUNITY. SINCE UNITAS IS THE MOST IMPORTANT NAVAL EXERCISE FOR MOST SOUTH AMERICAN NAVIES, SUBSTANTIAL NUMBERS OF MEN, SHIPS AND AIRCRAFT WERE COMMITTED TO MAKING IT A SUCCESS. THE TASK FORCE COMMANDER WAS RADM J.A. SAGERHOLM, USCOMSOLANT. OTHER U. S. PARTICIPANTS INCLUDED USS MACDONOUGH (DDG-39), USS DAVIS (DD-937), USS THOMAS C. HART (FF-1092) AND USS GATO (SSN-615).

O-IN-C's



EAST COAST—LCDR FRANK PAGANO (AND FRIEND)



WEST COAST—LCDR BOB ELDER

JULY—NOVEMBER 1976



PUERTO RICO	CREW 2,	CREW 10
BRAZIL	CREW 1,	CREW 5
URUGUAY	CREW 1,	CREW 8
ARGENTINA	CREW 7,	CREW 8
CHILE	CREW 3,	CREW 6
PERU	CREW 3,	CREW 12
COLOMBIA	CREW 4,	CREW 11
VENEZUELA	CREW 11	



SISTER CITIES PROGRAM: LCDR FRANK PAGANO AND LCDR DAVE BENNETT PRESENT GOODWILL TOKENS TO OFFICIALS OF BAHIA BLANCA, ARGENTINA, JACKSONVILLE'S SISTER CITY IN SOUTH AMERICA, DURING UNITAS XVII.



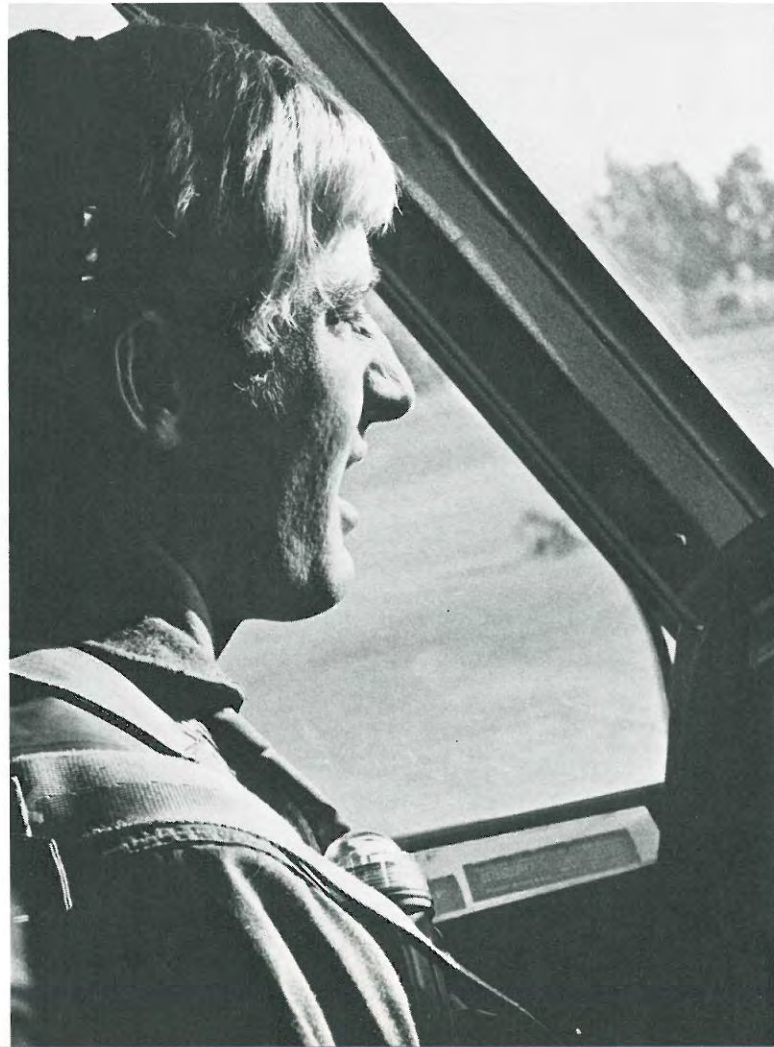



R 090304Z NOV 76
 FM CTF ONE THREE EIGHT
 TO PATRON FOUR FIVE
 INFO COMNAVAIRLANT NORFOLK VA
 COMPATWINGSLANT BRUNSWICK ME
 COMPATWING ELEVEN

BT

UNCLAS

UNITAS XVII

1. ON THE DEPARTURE OF PATROL SQUADRON FORTY-FIVE DETACHMENT UNITS FROM CTF 138, I EXTEND MY COMPLIMENTS ON THE SPLENDID PERFORMANCE OF YOUR UNITAS DETACHMENTS AND MY SINCEREST APPRECIATION FOR YOUR OUTSTANDING SUPPORT THROUGHOUT THE DEPLOYMENT. PATROL SQUADRON FORTY-FIVE FLIGHT CREWS WERE WELL TRAINED AND HIGHLY PROFESSIONAL, AND WERE MOST ABLY SUPPORTED BY THEIR MAINTENANCE PERSONNEL, AS REFLECTED BY THE HIGH LEVEL OF AIRCRAFT AVAILABILITY. YOUR MEN WERE EXEMPLARY REPRESENTATIVES OF PROFESSIONAL ASW AIRMEN AS WELL AS BEING EXCELLENT AMBASSADORS OF GOOD WILL ABROAD. THEIR ENTHUSIASTIC PARTICIPATION IN EVERY ASPECT OF DIRECT SUPPORT TO THE TASK FORCE CONTRIBUTED IMMEASURABLY TO THE SUCCESS OF UNITAS XVII. MY CONGRATULATIONS TO AN OUTSTANDING SQUADRON FOR A JOB WELL DONE.

RADM SAGERHOLM, USCOMSOLANT AND CTF 138

BT

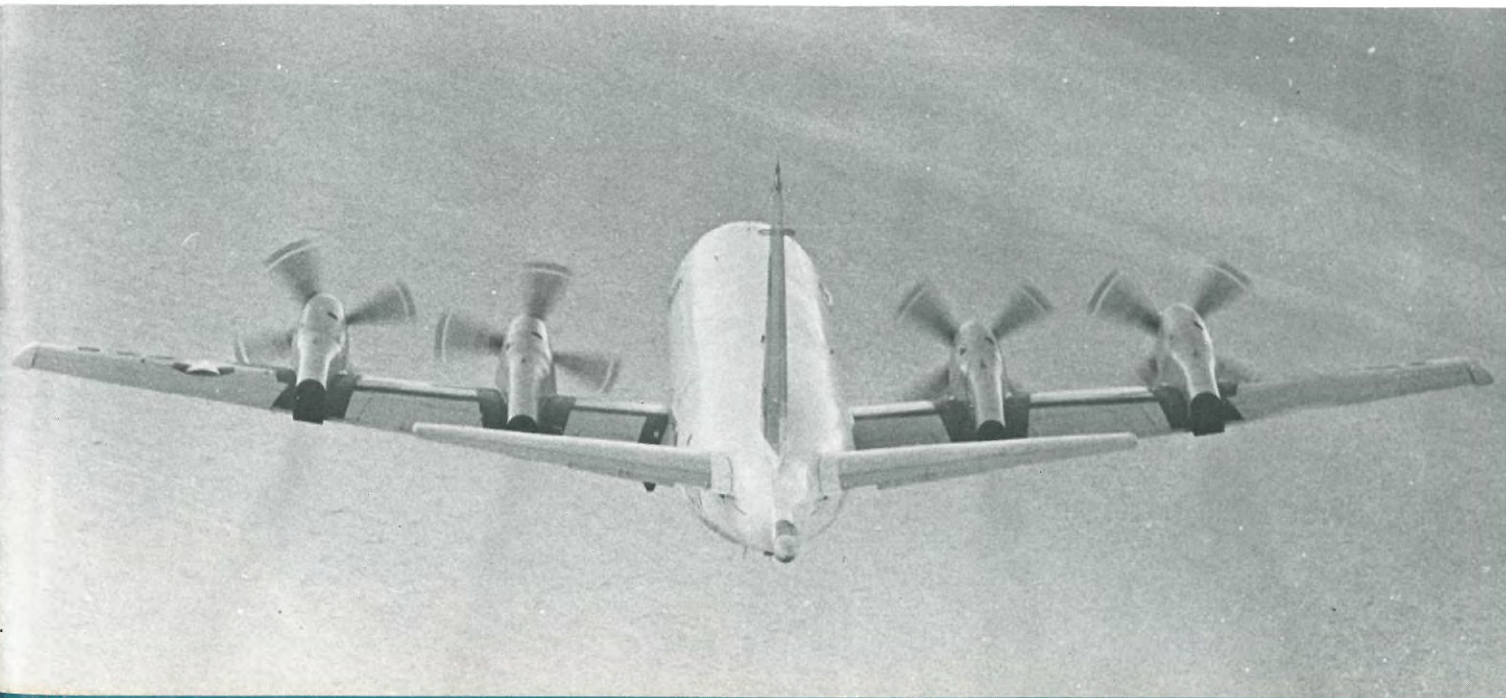

KEFLAVIK



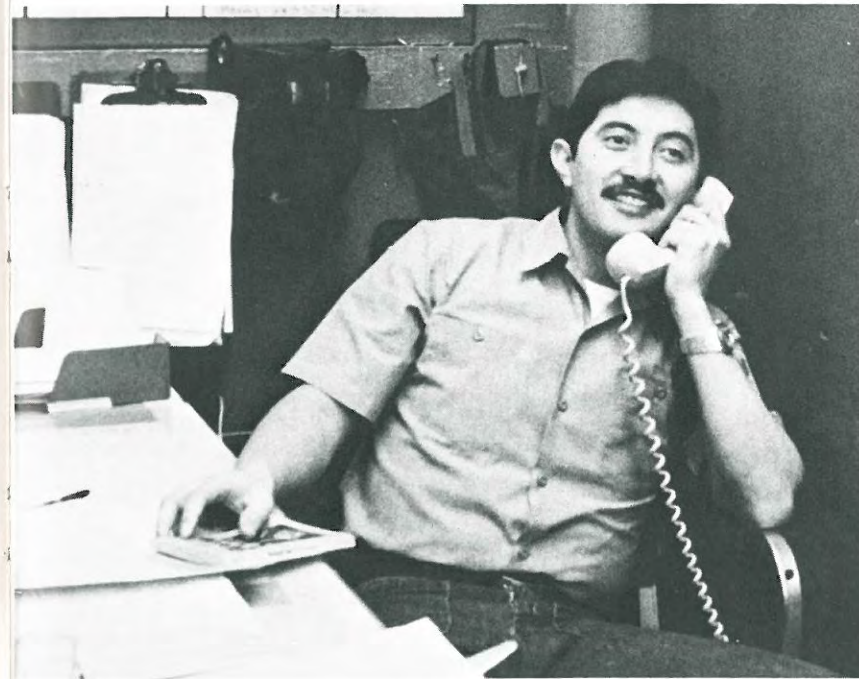
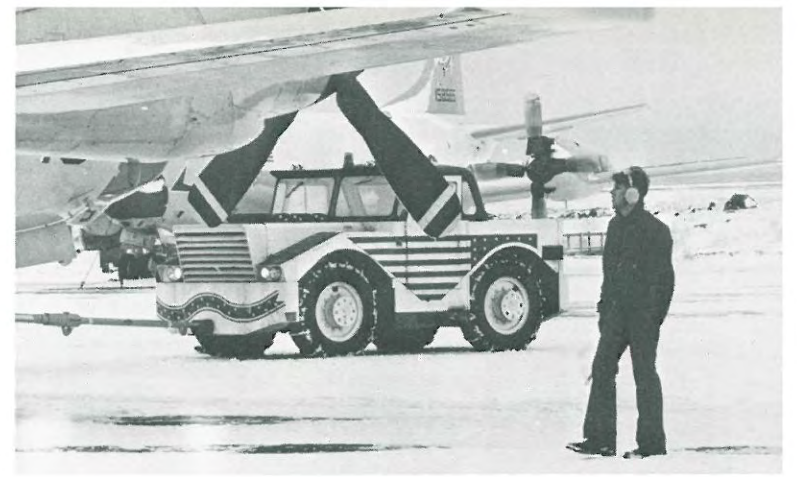

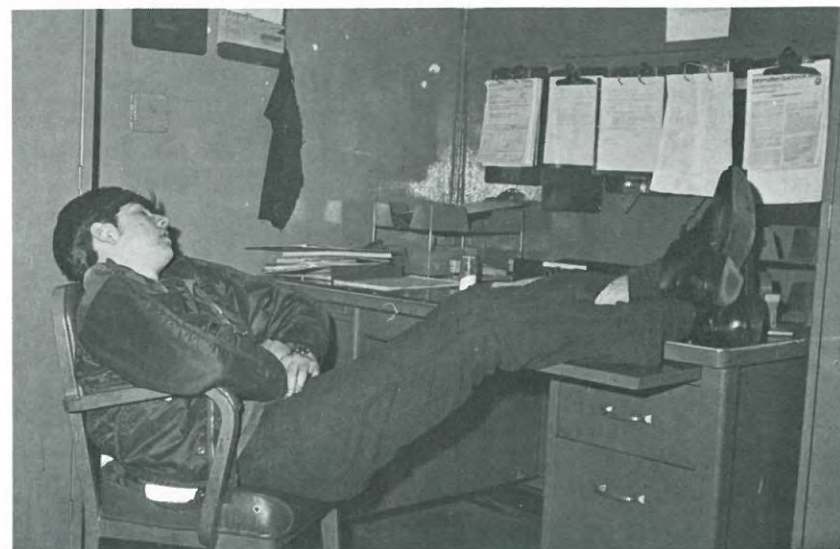
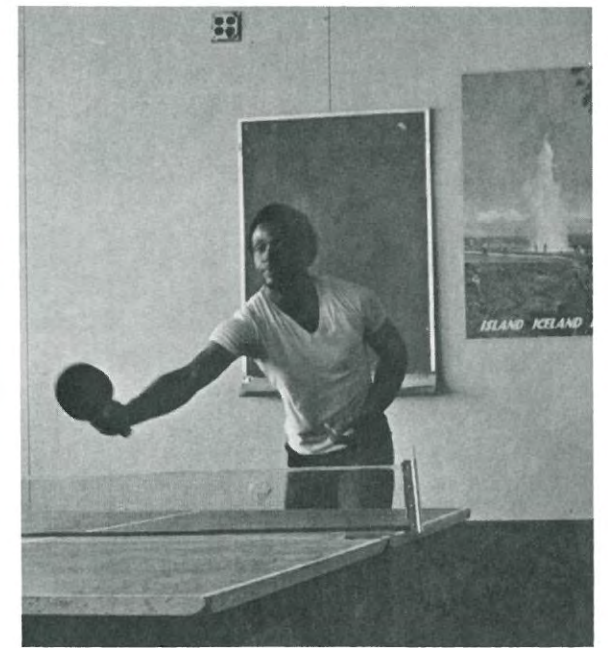
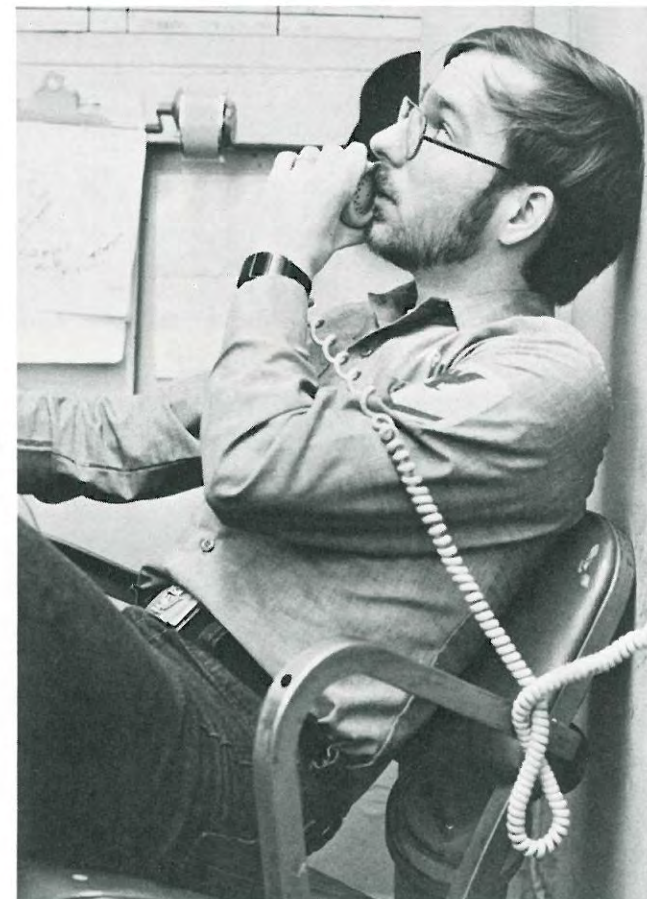
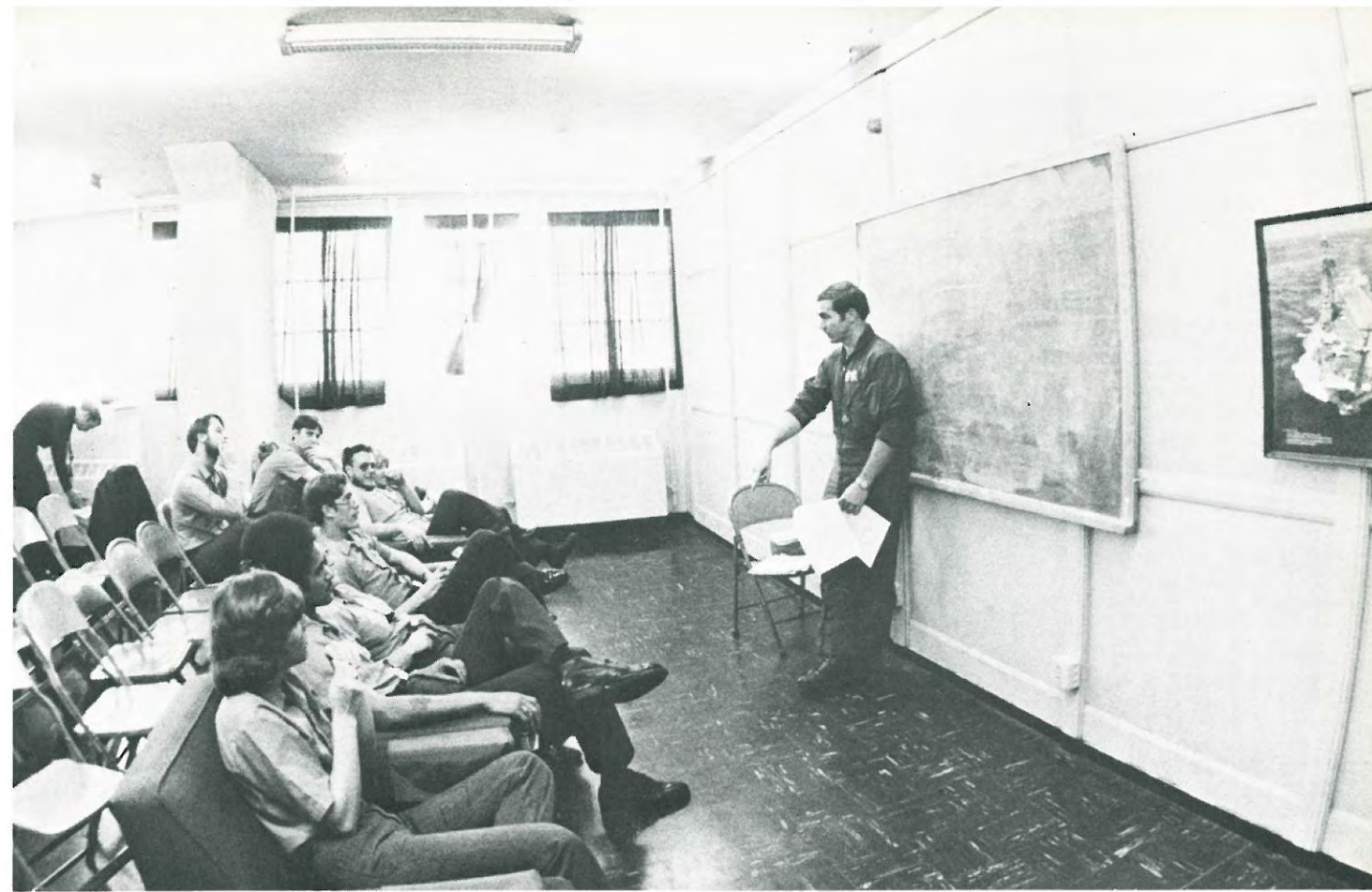

CREW ONE



FRONT ROW: AO1 KIMBERLING, AXC HERSHBERGER, AD1 MCCOLLUM, LCDR DYKEMAN, CDR LOFTUS, LTJG HOFFMANN, AW2 VANDYKE. STANDING: LTJG BLANKENSHIP, AWC AVERY, AW2 FARY, AMHC MOORE, AX1 JARRETT, LT BREWER, LT ROEDER, AWAN JACOBS

TACCO—CDR STEVE LOFTUS

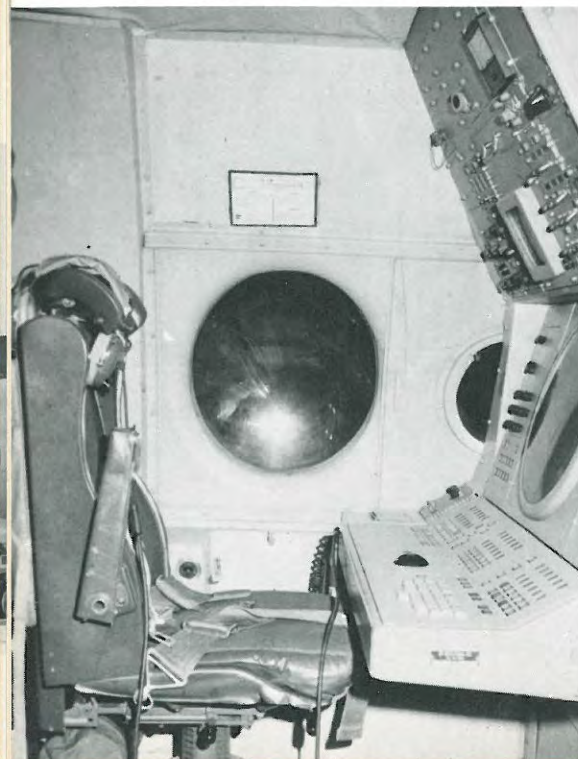
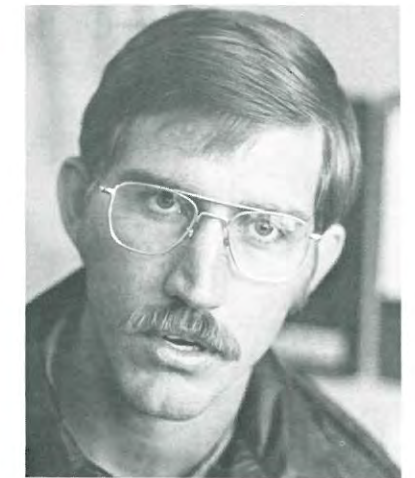

PPC—LCDR "SLB. PAUL" DYKEMAN

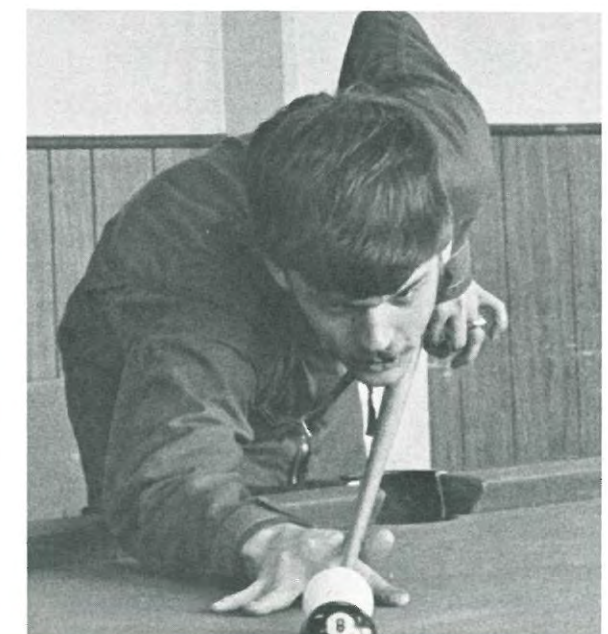
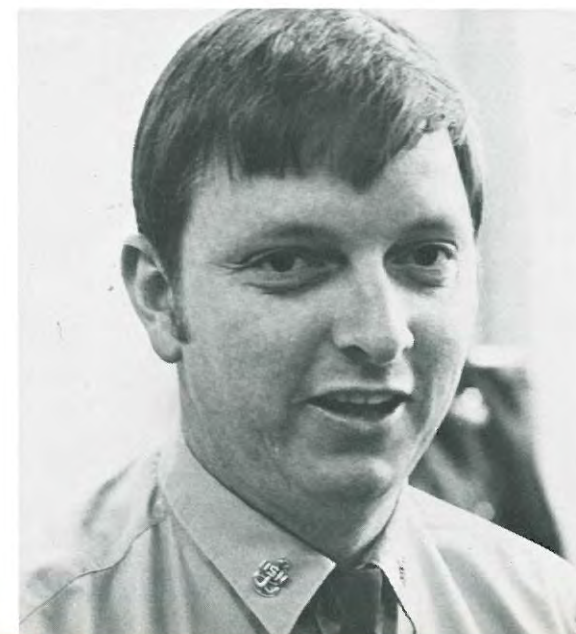



FRONT ROW: AO2 EMMONS, AT1 COLE, AMS2 CLARK, CDR MCKINNEY, AE1 BYERS, AW2 HUTCHINSON
 STANDING: LTJG BUFFINGTON, ENS GIFFORD, LT SNYDER, LT STANTON, LT MILLER, AW3 CALCOTE, AW1 HEMBLEY

CREW TWO

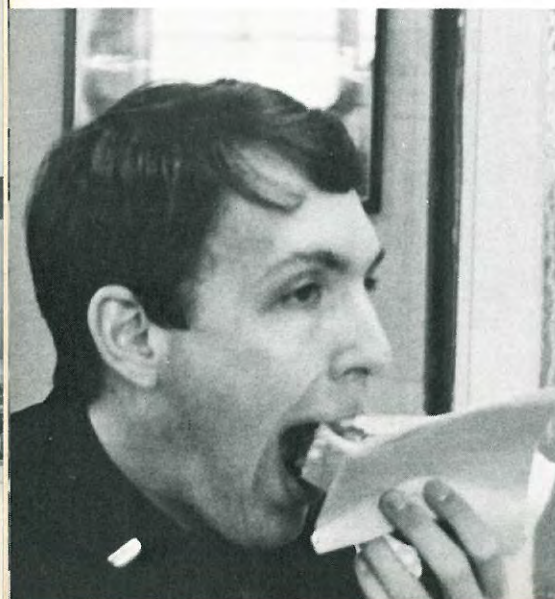

PPC-CDR CHARLIE MCKINNEY

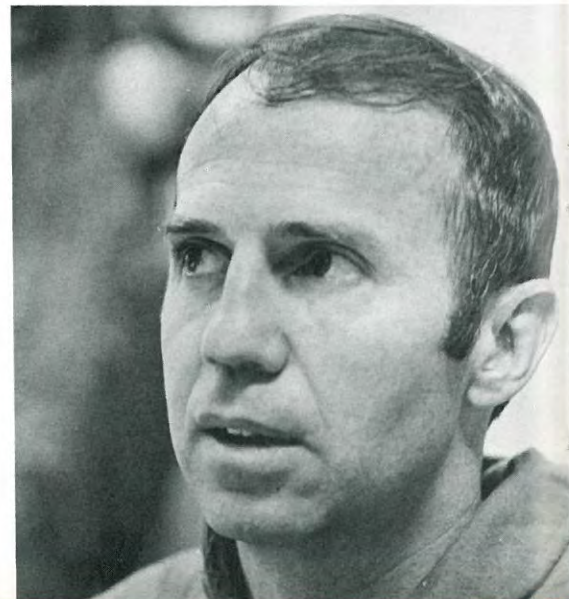

TACCO-LT BOB MILLER

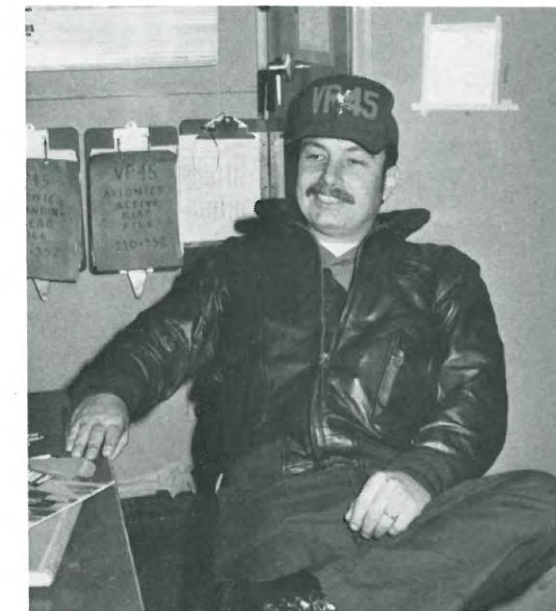

CREW THREE



FRONT ROW: LTJG DENMARK, LT ROBISON, LT FREEMAN, LTJG LINGLE, LTJG CLAUSEN. STANDING: AMH2 WARD, AO1 BROWN, AT2 KOERNER, AWAN NEFF, AW3 MARTIN, AW1 ROWE, AD1 BYRD

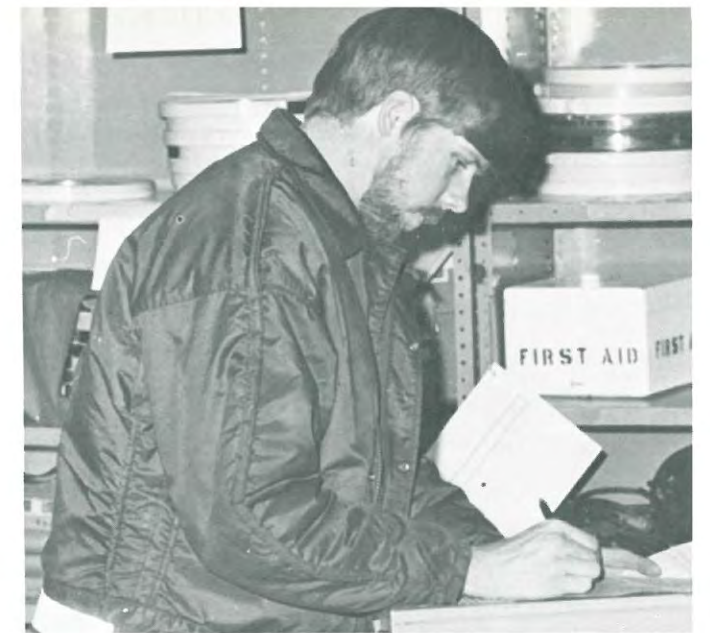

SN SCHMUCKATEL?

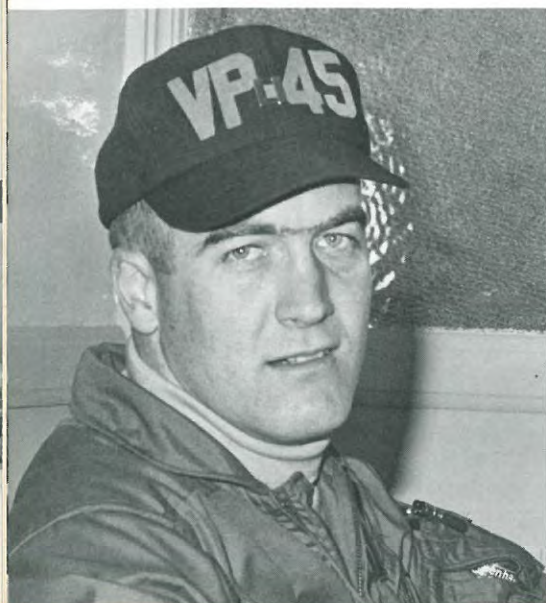

PPC-LT ROCKY FREEMAN



TACCO-LT RICH ROBISON

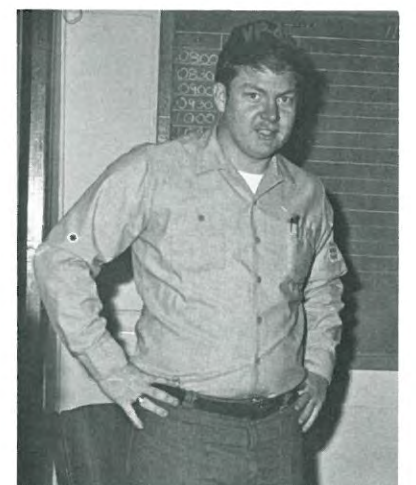

CREW FOUR



LT WATZL, AW2 MORLEY-MOWER, LTJG KINDER, ADC HINES, LT CUNNINGHAM, AO2 JOLES, LTJG REINHARDT, AW1 DYSON, AW2 DEWIRE, LTJG WHITE, AX1 ANDERSON, AE1 KEIFFER



ENS ROSE

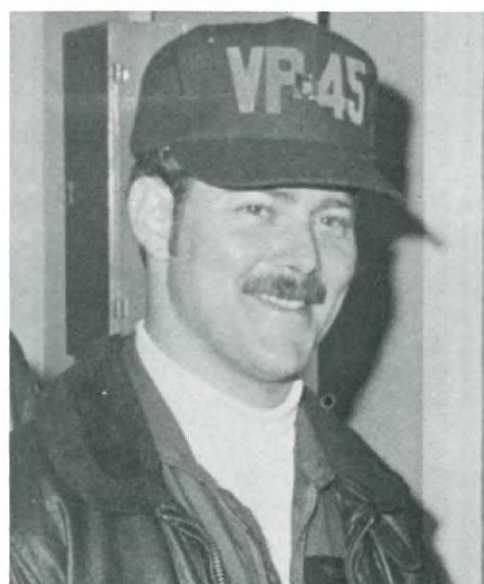

PPC-LT RICH CUNNINGHAM



TACCO-LTJG DICK "HOW-DO-YOU-LIKE-ME-SO-FAR" KINDER

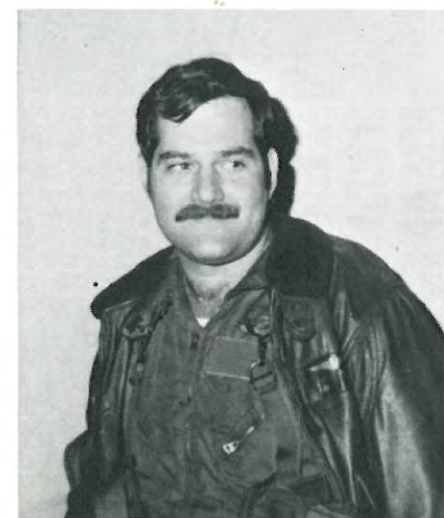
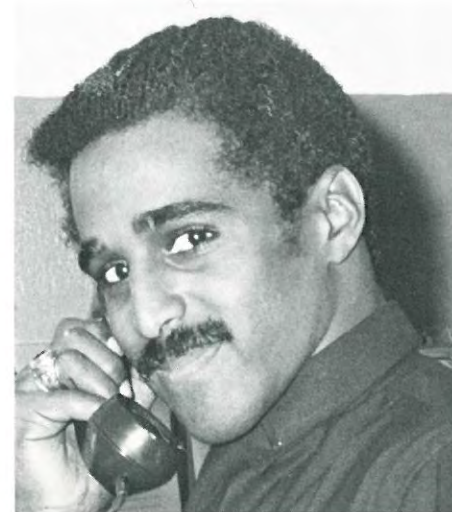

CREW FIVE



FRONT ROW: LTJG MCCLELLAN, AO2 SWILLEY, AW3 MORRIS, AW3 BEE, AW1 BROXSON, AO1 HAYDEN, AWAN MILLER. STANDING: LTJG BLAKE, LT THOMPSON, LTJG KOZIKOWSKI, ADC POLLARD, LCDR WILSON, AX2 RAPER, LT HARDING.

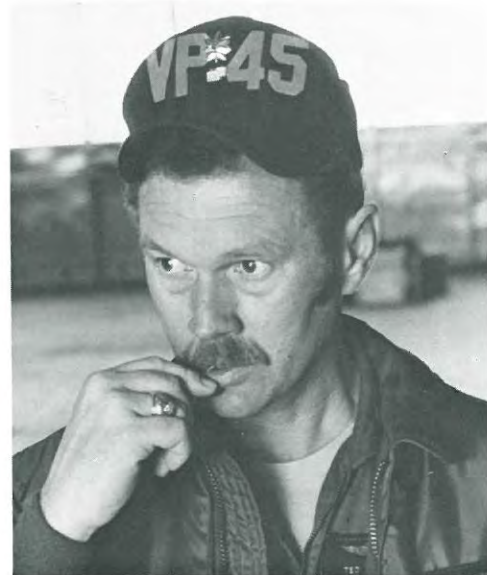

PPC-LCDR TED WILSON



TACCO-LT DON THOMPSON

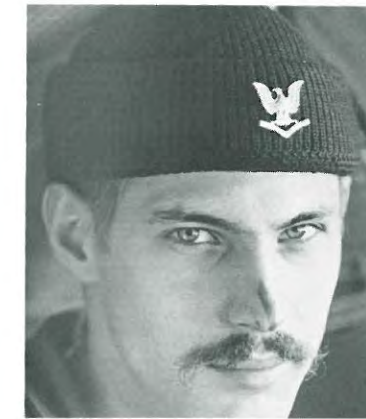
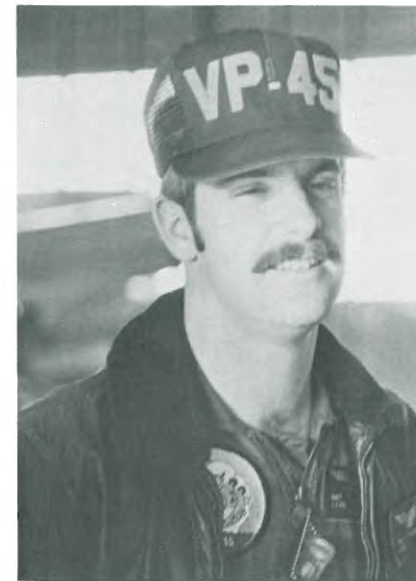

AMS2 KIRBY

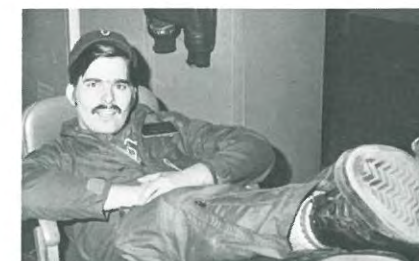



FRONT ROW: AO2 KEARLEY, LT SHULER, AW2 HENNESSEY, LT OWENS, LTJG RICH. STANDING: AW2 WHITE, AE1 EASTMAN, AX1 ROGERS, AW1 CHITTICK, AD3 RAWLINS, LTJG KERNAN, LTJG C. D. MILLER.



CREW SIX

PPC-LT ANDY OWENS

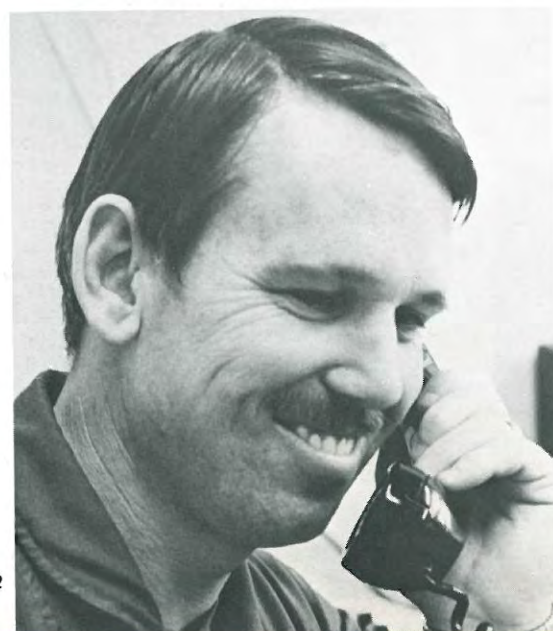

TACCO-LT STAN SHULER





FRONT ROW: ENS TISDALE, LT JOHNSON, LTJG J. MILLER, LCDR BENNETT, LT MOSELEY, AE1 DUNMAN. STANDING: AT1 BALENTINE, AW2 WALSH, AW2 COLLIER, AW3 RUKES, LTJG ANDERSON, AO2 BOGGS, AD2 BARTON

CREW SEVEN

PPC—LT BOB MOSELEY

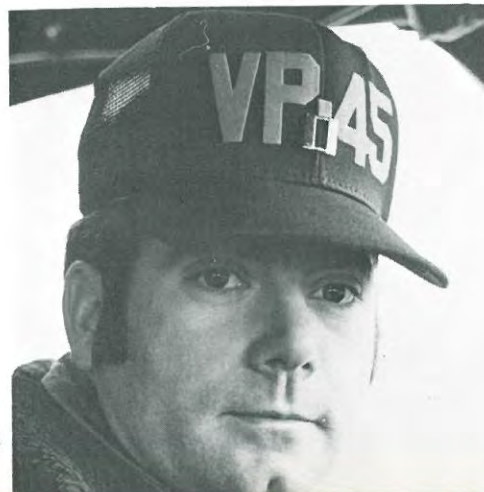

TACCO—LCDR DAVE BENNETT

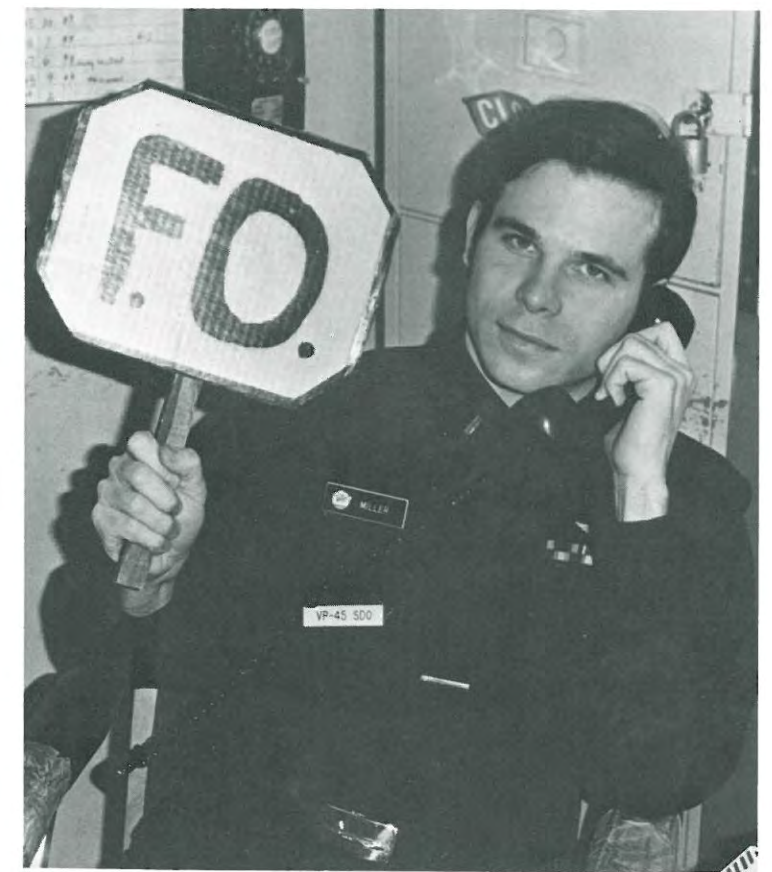
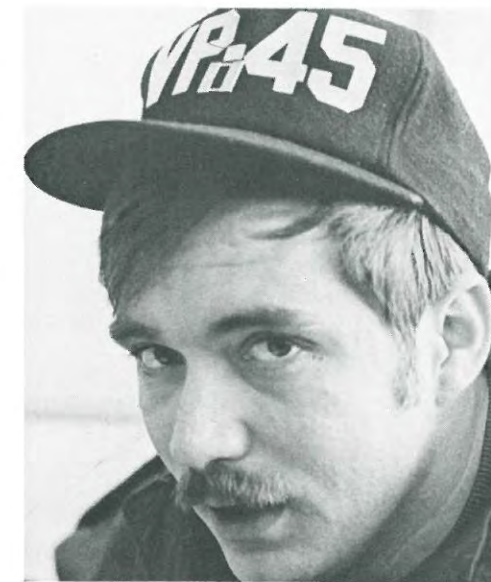



FRONT ROW: AW2 STRAND, AO2 FOSTER, LTJG KNICHEL, LTJG HARMS. STANDING: AW3 PETERSEN, AD2 MORRIS, AT1 PASANEN, LT WAGNER, LTJG SHOCKLEY, FLT LT WIGHT-BOYCOTT, AD3 CARROLL, FLT SGT BREE.

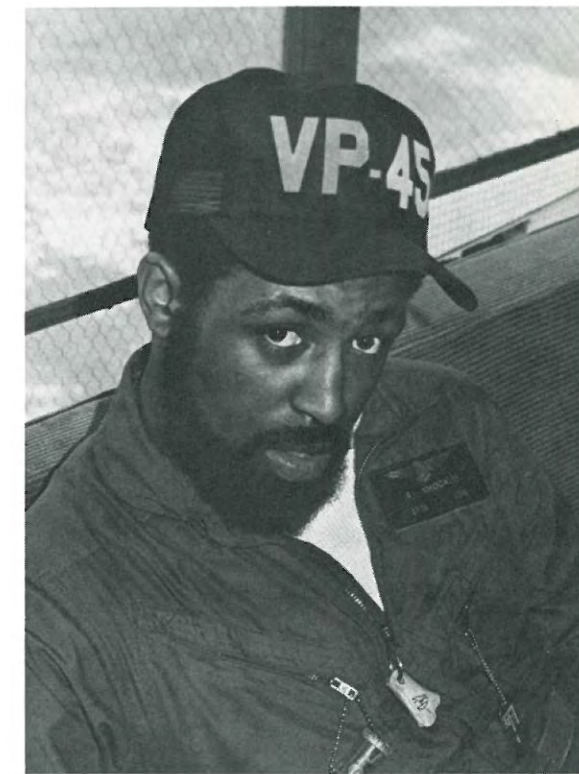
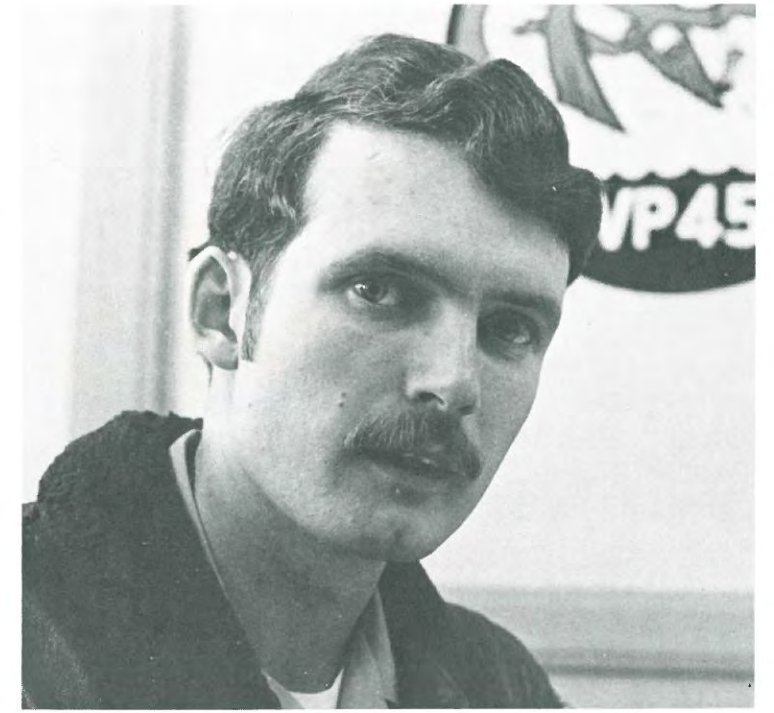

CREW EIGHT

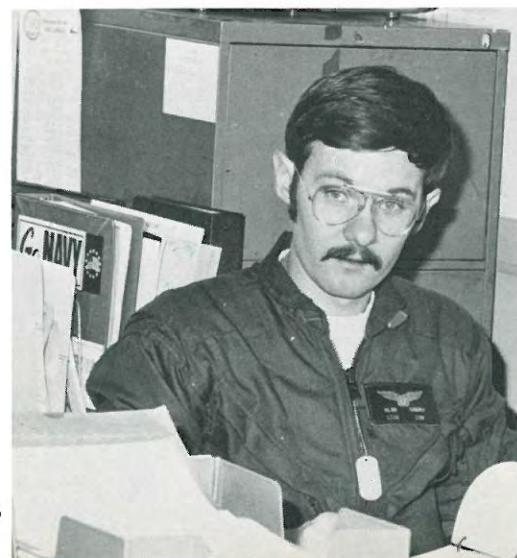

FLT LT ANDY WIGHT-BOYCOTT

LTJG AL HARMS



CREW NINE



SEATED; AW3 BARCALOW, LTJG FRICK. STANDING: AW3 PARDO, ADC MCGOUGH, AMH2 PETERS, AW3 BROWN, LT SCOTT, AW2 MOUNT, LT MCCRORY, AO3 GREEN, LTJG MANN, LT NOAK.



LCDR CLARKE

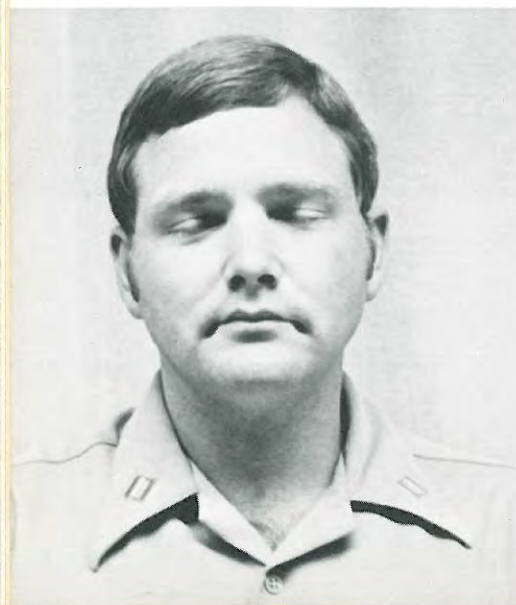
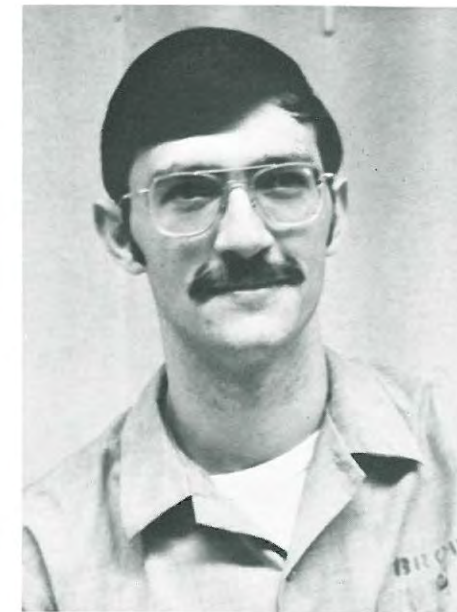

PPC-LT "FAT PETE" SCOTT (IN TYPICAL FLIGHT CONFIGURATION)



TACCO-LT RALPH "LASLO" MCCRORY



CREW TEN



FRONT ROW: LT RICHEY, AD3 VANASSCHE, AW2 NOBLE, AD2 KISSINGER, AXC HORNING. STANDING: AW2 ROWE, LT MARTEL, AO2 BROWN, LT SHERMAN, LCDR ELDER, LTJG ABERNATHY, AWAN DOBBINS.

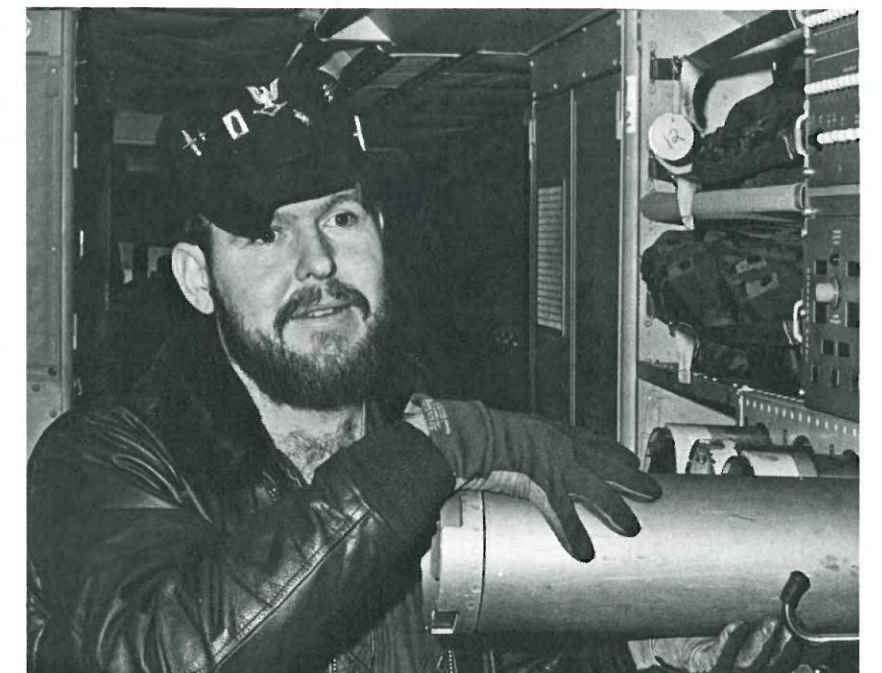

TACCO—LT TIM "KILLER" MARTEL

PPC—LCDR BOB "BIG BIRD" ELDER

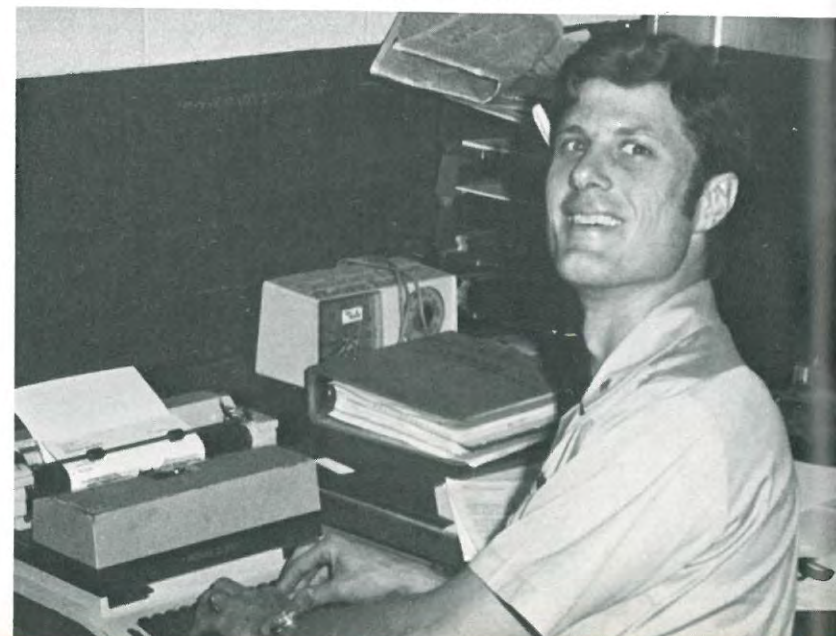



FRONT ROW: FLT LT HALL, LTJG MYERS, LCDR MINDERLEIN, AO2 RODDAM, ADI MIDDLETON, FLT SGT MILLS. STANDING: AW2 STRINGFELLOW, ADCS CHRISTOPHER, AT1 NEAL, AW2 LANGLEY, LTJG DRENNAN, AW3 BAGBY, LTJG PAHA.



CREW ELEVEN

PPC-LCDR JIM "MR. COMMAND" MINDERLEIN

LT STIFFLER

TACCO-FLT LT BOB HALL

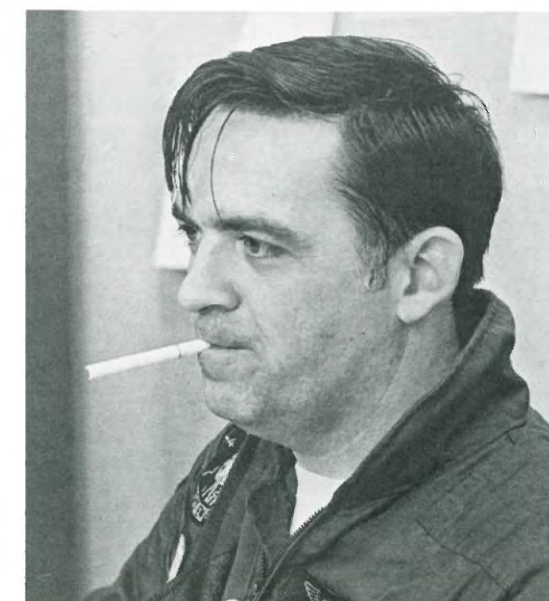

HUK TWELVE



FRONT ROW: AWAN PICKETT, LCDR BAKER, LT CREATH, LTJG FISHER, AW3 PALENSKY. STANDING: LT BELONCIK, AW2 CAUDLE, ADC MISSLER, AT1 BARBEE, AW2 LOAR, AD2 MOORE, AO1 HALL

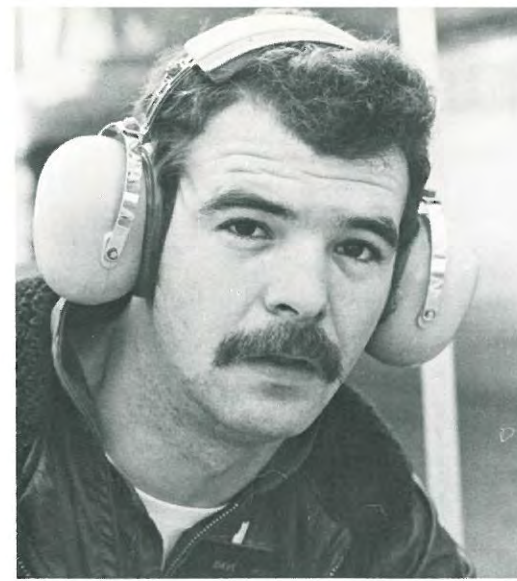

AWAN PAETH



LTJG AYERS

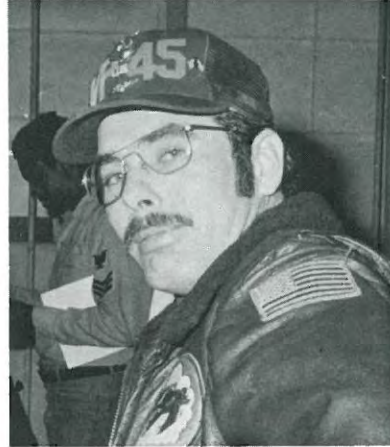

PPC-LCDR RON BAKER



TACCO-LT TIM CREATH



PATROL SQUADRON FORTY-FIVE
OFFICERS

CDR STEVEN F. LOFTUS, C. O.
CDR CHARLES J. MCKINNEY, JR., X. O.
CDR CHARLES B. COLLMAN
CDR GEORGE F. WRIGHT
LTJG JACK L. ABERNATHY, JR.
LTJG JOHN C. ANDERSON
LTJG RONNIE L. AYERS
LCDR RONNIE B. BAKER
LTJG ROBERT L. BANFORD
LT HARRY T. BAXTER
LT CHRIS J. BELONCIK
LCDR DAVID C. BENNETT
LTJG WILLIAM R. BLAKE, JR.
LTJG DAVID D. BLANKENSHIP
LT DONALD S. BREWER
LTJG JOHN G. BUFFINGTON
CWO3 JOHN E. BUTLER
LT MERLE P. CHRISTENSEN
LCDR FREDERICK T. CLARKE
LTJG ROGER G. CLAUSEN
LT TIMOTHY G. CREATH
LT TERRY A. CRESCIMANNO
LT RICHARD M. CUNNINGHAM
LTJG RICHARD F. DENMARK
LTJG BRUCE C. DRENNAN
ECDR PAUL R. DYKEMAN
LCDR PHILIP R. ELDER
LTJG EARLE B. FISHER
LT HAROLD R. FREEMAN
LTJG STEPHEN A. FRICK
LTJG WLADISLAW GAMBERGER
ENS ALFRED J. GERTSCH, JR.
ENS GREGG C. GIFFORD
FLT/LT ROBERT HALL
LT RICHARD W. HARDING
LTJG ALAN M. HARMS
ENS KENT H. HITE
LTJG ARTHUR D. HOFFMANN
LT BRIAN F. IUVONE
LT LEO T. JOHNSON, JR.
LTJG LESTER JOHNSON
LTJG ROBERT F. KERNAN
LTJG RICHARD A. KINDER
LTJG RONALD K. KIRKER
LTJG RAYMOND J. KNICHEL
LTJG RAYMOND T. KOZIKOWSKI, JR.
LTJG NORMAN H. LAWTON
LTJG DENNIS J. LINGLE
ENS JOSEPH F. LUDWIKOWSKI, JR.
LTJG CHARLES H. MANN, JR.
LT REGINALD T. MARTEL
LTJG THOMAS R. MCCLELLAN
LT RALPH C. MCCROY
LT GEORGE R. MCKINNEY, III
LTJG CECIL D. MILLER, JR.
LTJG JOHN H. MILLER, JR.
LT ROBERT L. MILLER
LCDR JAMES L. MINDERLEIN
LTJG ROBERT L. MITCHEM
LT JAMES R. MOSELEY
LCDR BARRY L. MULLEN
LTJG RICHARD C. MYERS
LT ROBERT F. NOAK
LT WILLIAM A. OWENS
LCDR FRANK P. PAGANO
LTJG EDMUND J. PAHA
LT THOMAS L. PARTIN
LTJG PETER J. REINHARDT
LTJG BRIAN C. RICH
LT STEPHEN T. RICHEY
LT RICHARD A. ROBISON
LT JOHN A. ROEDER
ENS STEPHEN W. ROSE
LT ROBERT P. SCOTT
LT CHRISTOPHER M. SHERMAN
LTJG RODNEY C. SHOCKLEY
LT STANLEY C. SHULER
LT THOMAS D. SNYDER
LT MARTIN M. SPOLARICH
LT DONALD C. STANTON
LT MARK A. STIFFLER
ENS WARREN L. TISDALE

LT DONALD R. THOMPSON
LT JOHNNY C. VILLINES
LT WILLIAM J. WAGNER
LT DONALD P. WATZL
LTJG RICHARD O. WHITE, JR.
LCDR TORRENCE B. WILSON
FLT/LT ANDREW WIGHT-BOYCOTT

PATROL SQUADRON FORTY-FIVE
CHIEFS

YNC ROLAND A. ACHORN, JR.
AWC KENNETH R. AVERY
AWCS STUART A. BABINS
FLT/SGT PETER M. BREE
ADCS RONALD CHRISTOPHER
AWCS RAYMOND E. CHUTE
HMC THOMAS D. CRISP
AMHC BILLY DEARMAN
AXC CECIL D. EUBANKS
ADC GERALD K. FARRELL
ATC CHARLES R. FRANKS
AMHC DORSEY C. GLADDEN
YNC ROBERT A. HECHT
AXC JAMES H. HERSCHBERGER
ADC JAMES W. HINES
ADC FRANK F. HOGARTH
ATCS EDMOND F. HOLT
AXC LAWRENCE L. HORNING
AFCM BERNARD F. KEMPER
ATC WILLIAM T. KULIER
AMSC CHARLES W. LANCASTER
ADC THURMAN T. MCGOUGH
FLT/SGT ALAN M. MILLS
ADC WILLIAM R. MISSLER
AMHC FRANK G. MOORE
AVCM GEORGE G. MORRISON
AEC LEO M. NAU
AMCS THEODORE A. NIERMAN
AKCS WILLIAM M. OLIVER
AXC EVERET OVERTURF
AWC SAMUEL E. PERKINS
ADC MARION A. POLLARD
ADCS GORDEN RICHAU
AWC BEN J. ROBINSON
AEC RICHARD L. ROWE
AMEC SIDNEY C. SMITH
AMSC JOHN E. STAGGS
ADCS JAMES M. STONER
AOC HENRY STOPINSKI
ATC JOHN B. TANNER
ADC JIM K. THAENS
AEC GEORGE VICKERS
AEC TEDDY J. WALTERS
AEC RAYMOND L. WILMER

ENLISTED PERSONNEL

PN3 MICHAEL W. ACKERMAN
PR2 GARY S. ADKINS
AZ1 JAMES M. AGEE
DK1 CESAR V. AGUIRRE
AE2 PHILLIP C. AGEE
AN BILLY E. ALSUP, JR.
AX1 JACK O. ANDERSON, JR.
AW3 FRANK R. BAGBY
AT1 THOMAS B. BALENTINE
AMS3 CLYDE W. BALLINGER
MS2 SANTOS P. BANTAG
AA JOHNIE E. BARBAS
AT1 STEPHEN N. BARBEE
AWAN FRANCIS J. BARCALOW
YNSN ROLAND K. BARKER
AMS1 JOHNNY S. BARLOW
PN2 DAVID BARRON
AD2 WILBERT R. BARTON
MSSN JOHN H. BECKER
AW3 MARK W. BEE
ISSN VINCENT A. BERG
YN2 WILLIAM BERGBAUER
YN2 CHARLES A. BERGQUIST
ADAR RAY E. BERRY
AE2 JAMES A. BISHOP
AR DONALD M. BLACK
AN MARTIN P. BLAHA

AO2 JOHN A. BOGGS
ASM3 WENDELL BONNETTE
ABH3 CARL V. BOWSER
AMH2 KENNETH W. BRADFORD
AA DAVID A. BRANT
AD2 JOSEPH H. BRETTON, JR.
AA RODNEY K. BREWER
AK3 JAY R. BREWSTER
AZ2 DAVID E. BRIGHT
AD3 JAMES M. BROCKMAN
AW3 GREGORY F. BROWN
AO1 JERRY E. BROWN
AO2 JERRY L. BROWN
AX1 WILLIAM BROWN
AO2 ROGER A. BROWN
AW1 JOSEPH C. BROXSON
YN3 BENJAMIN BRYANT
AN RUSSELL E. BUBB, JR.
PNSA TIMOTHY BULLOCKS
MS1 RAUL R. BUNDANG
AA MEDARUS H. BUNDY
AE1 FREDDIE E. BYERS
AD1 FELTON J. BYRD, JR.
AW3 ROBERT W. CALCOTE
AXAN SCOTT CAMPBELL
AME3 GREGORY L. CASAVANT
HM1 HENRY L. CARABALLO
ADAN MICHAEL CARROLL
MS1 EDDIE CARTER
LN2 LARRY A. CARTER
AE2 KENNETH E. CARY
AW2 RICHARD E. CAUDLE
AW1 EUGENE F. CHITTICK
PH3 GORDON CHRISTENSEN
PH3 JAMES R. CISSELL, JR.
AA JERRY L. CLARK
AMS2 JOHN T. CLARK
AMSAN JOHN R. CLARKE
AX2 WILLIAM CLEMONS
AE3 RICHARD L. CLOYD
AD1 DANIEL W. COGSWELL
AT1 JAMES E. COLE
AW2 THOMAS M. COLLIER
ASM3 RICHY R. COOK
MS3 RAYMUNDO M. COSCA
AX3 MONTE M. CORNWELL
AD1 KENNETH B. COTTRELL
AE1 JAMES J. COX
AO1 JAMES EDWARD COYLE III
YN1 MANUEL CUEVAS
AMHAA BRIAN E. CURYLO
AX3 MAX F. DAVIS
AD1 VINCENT W. DAVIS
AT2 GARY R. DEARING
AN SAMUEL L. DENSON
AW2 MICHAEL E. DEWIRE
AE2 DAVID G. DICKSON
AWAN DANNY J. DOBBINS
DK1 AURELIO DOMINGO
AMSAN RODNEY S. DONNELL
AE1 JERRY DUNMAN
AW1 STEPHEN R. DYSON
PR2 LARRY W. EADS
AO2 TRACY J. EALY
AE2 JOHN H. EASTMAN
AD3 MICHAEL EBERSOLE
AK1 NEVIN H. ECKERMAN
AO3 DENNIS E. EDDINGS
AXAN WILLIAM R. EDWARDS
AD3 ROBERT R. ELLIOTT
AO2 DANNY L. EMMONS
AE2 CLARENCE D. ENNIS
AZ3 HORACE S. EPPERSON
AE3 KENNETH B. ERRICKSON
PN2 JOSEPH E. FABRY
AMH3 SAMUEL P. FARR
AN MICHAEL J. FARRELL
AW1 ROBERT E. FARY
AT1 DONALD G. FAUST
ABH2 JOSEPH D. FAVICHIA, JR.
AMS2 JAMES T. FAY
AOAA KIRBY R. FLUHARTY
AR EDWARD T. FLOSYTH, JR.
AO2 SAMUEL E. FOSTER
AEAN BRADLEY C. FRITCHMAN

PN3 DENISE GALLIGAN
AR MICHAEL E. GARRETT
AMH2 LIBERATO GENERAL
AD2 RONALD GENTRY
AXAN EDWARD L. GETTEL
ABHAA GREGORY B. GIFFORD
AN LARRY GILLESPIE
AA DAVID GIROUARD
AT2 ALLEN L. GLENN
AXAN MICHAEL GOETSCH
AN BENJAMIN B. GOZAR
AX3 BARRON D. GREEN
AOAN CLAYTON J. GREEN
AW3 DAVID D. GURLY
AMHAN JOHN R. HAENSLY
AMHAN ROBERT G. HAIGHT
AWAA CLIFFORD H. HAHN
IS3 ARTHUR M. HAINER
AO1 EDDIE C. HALL
AMSAA WILBERT L. HALL, JR.
AO2 ROBERT E. HAMILTON
AMS1 ROY L. HANES
PNSN DEAN A. HARMSEN
AT2 DANIEL M. HARPER
PR3 ROBERT W. HARRIS, JR.
PH3 KENNETH J. HART
PR2 GARY B. HARTLEY
AR JIMMIE L. HASSELL
AO1 JAMES E. HAYDEN, JR.
AMH3 PATRICK W. HEAPS
AN TERRY L. HEAPS
AW1 THOMAS J. HEMBLY
AXAN PATRICK A. HENBLY
AO1 ROBERT E. HENNEMAN
AW2 TIMOTHY P. HENNESSY
AMSAA ROBERT W. HENNIS
ASM2 GARRY W. HENRY
ATAN STAN L. HERNANDEZ
AZ2 THOMAS O. HILL
AT1 ROBERT T. HOCKERSMITH
PHAN DONALD W. HOLMES II
AX3 JOHNNY R. HUBBARD
AXAN DAVID R. HULL IV
SN DOUGLAS R. HUMBLE
AW2 ROBERT M. HUTCHINSON
AX2 JOSEPH L. ICARD
PAAR ROBERT ISSACSON
AE3 BRIAN D. IVES
AWAN GEORGE J. JACOBS
AX1 CHARLES C. JARRETT
PN3 LARRY N. JOHNSON
AD1 RICHARD M. JOHNSON
ADAN JON D. JOHNSTON
AO2 JAMES A. JONES
AK2 BENJAMIN L. JONES
AX3 WILLIAM G. JONES
AMS3 RUSSELL A. JURGENSON
AMSAA WAYNE KAMPFENKEL
AWAN STEVEN C. KAPSAR
AO2 CHARLES KEARLEY
AMSAA ROBERT A. KEENE
AE2 MICHAEL KEIFFER
ATAN LEONARD D. KENNON
AD1 HAROLD C. KEYLON, JR.
AME3 JAMES R. KEYSOR
AO1 KENNETH KIMBERLING
AD1 JOHN M. KIMBRO
AEAN EDWARD P. KINDINGER
ANS2 WALLACE C. KIRBY
AME3 GARRY J. KISER
AMH2 ROBERT W. KISSINGER
AK6 JEROME KITTLES
AX1 DUANE E. KNAFFLE
AT2 MARK W. KOERNER
AEAN JEFFREY A. LADD
AD3 MICHAEL G. LAMBDIN
AW2 JOHN F. LANGLEY
AD1 JACK L. LANKFORD
AX2 HUBERT K. LANTZ
AMS2 PHILLIP D. LASTER
AZAR HUBERT R. LEE
HM2 THOMAS A. LEHN
AN REINALDO D. LEITAO
AMS2 ROBERT LEWIS, JR.
PN3 PATRICIA M. LILLPOP

AW2 ROBERT D. LOAR
AW1 DANIEL MAJKUT
YN3 ROBERT P. MANLY
AW2 MICHAEL G. MARTIN
AZ3 JAMES M. MATHIS
AMS2 ROBERT MATHISON
AD2 STEVEN C. MAXVILL
AZ1 EVERETT E. MCCAIG
AX3 CARL G. MCCALL
AD1 HAROLD C. MCCOLLUM
PNSA GEORGE K. MCGEE
AD3 CARL E. MCGUIRE
AT3 RICHARD MEDCALF
AO1 JOHN T. MEKLER
YN3 RICHARD F. MELVIN
AX3 PAUL A. MEYER
AD1 SAMUEL W. MIDDLETON
AA LESLIE M. MILES
AWAA GREGORY L. MILLER
AA MATTHEW S. MILLER
AD3 WILLIE L. MILLER
AO2 REGINALD M. MILLETT
AN BRYAN T. MINK
PH2 EDWARD J. MINNICK
AD1 WALTER J. MISORA
AMHAA PAUL E. MITCHELL
AD2 EDDY A. MONNIER
AX1 ALEC V. MONTE
AD2 DAVID E. MOORE
AMH2 WILLIAM R. MORAN
AW3 ANTHONY MORLEY-MOWER
AW3 FRANK R. MORRIS
AD2 MICHAEL R. MORRIS
AZ2 EDWARD M. MORRISON
AW2 JOHN W. MOUNT
AMS3 MICHAEL S. MUCHA
PN3 PHILLIP H. MULLEN, JR.
AE3 PATRICK C. MULVANY
AO2 FRANKLIN L. MURNAHAN, JR.
AE1 WILLIAM NABORS
AT1 ROGER F. NEAL
AWAN TIMOTHY W. NEFF
ADAN GARY C. NEISTER
AD2 MICHAEL L. NICELY
AO2 STANLEY W. NICELY, JR.
AW2 CARL L. NOBLE
AT3 MARK A. NOVAK
SN DANNY L. NUNLEY
AD2 GUILLERMO ORDONEZ
AE3 CARL R. OWENS
AWAN LEON R. PAETH
AW3 MANUEL PARDO
AW3 DANIEL L. PALENSKY
AT1 WAYNE W. PASANEN
AR WILLIAM G. PATTIERSON
AT1 JOSEPH J. PAZZELLI
AX1 VICTOR H. PELL
AEAN GARY D. PETERSON
AWAN PAUL D. PETERSON
AMH2 ROBERT J. PETERS
IS2 JAMES E. PHELPS
ADAA GILBERT PLUMMER
AWAA SCOTT D. PICKETT
ABH3 EUGENE PIERSON
ASM2 JAMES W. POLYBLANK
AN ALFRED C. POWELL
AMH2 GLENN QUINLEY
AX2 HORACE E. RAPER
AX2 GARY A. RATHER
AA DANIEL RATHJEN
AD3 GARY RAWLINS
AE3 DANNY C. RAY
AO3 PHILLIP C. REED
AXAN WILLIAM P. REED
AA EDWARD L. REID
AE3 RICHARD REIMER
YN3 DONNIE W. RHODES
AX2 SAMMIE ROBINSON
AO2 CLIFFORD RODDAM
AOAN ANTONIO RODRIGUEZ
MS3 LEOPOLDO RODRIGUEZ
AX2 WILLIAM C. ROGERS
PN2 KENNETH R. ROSE
ABH1 JAMES L. ROULSTON
AW3 JOHN B. ROWE

AW1 RICHARD L. ROWE
AD2 STANLEY A. RUSSELL
AN JOHN E. RUTHERFORD
AK2 GERARD A. SAMUEL
AN FREDDIE D. SARASUA
AW1 DONNIE SCARBOUROUGH
ABHAR RICHARD R. SCHMIDT
AZAA MICHAEL SCHOOLMEESTERS
AA JOHN J. SCOTT
AO2 JAMES A. SELIG
AD2 LAWRENCE J. SEVCIK
AMH2 RONNY D. SKELTON
YNSN RUSSELL P. SKINNER
AWAN PAUL J. SKIVER, JR.
AK3 MARK G. SMITH
AMH2 ROBERT E. SMITH
AA ROBERT G. SMITH
AX2 WILLIAM O. SMITH
AMHAN DAVID P. SPARROW
AE2 LAYCE G. STANLEY
AMSAA GLENN P. STAPLETON
AME2 THOMAS A. STARRITT
AT2 WILLIAM J. STEINMETZ
AE1 RICHARD A. STINE
AD1 JACKIE D. STOUT
AW3 LLOYD E. STRAND
AW2 GEORGE STRINGFELLOW
AD3 GERALD E. STUCK
AO2 WILLIAM A. SWILLEY, JR.
ASM2 ROBERT S. TAIT
AE3 STEPHEN A. TAYLOR
AR DENNIS J. THIBAUT
AME3 PATRICK A. TINNEY
AN KEVIN W. TITUS
ATAN DAVID L. TOLBERT
AZ3 STANLEY C. TRCKA
AEAN JEFFREY TRIBBY
AD3 SAMUEL L. TRIKILAS
IS2 PAUL S. TROESTER
MS1 ARTURO P. TUASON
AO1 TOMMY L. USSERY
AD3 WAYNE L. VANASSCHE
AW2 ROBERT D. VANDYKE
PRAN DONALD L. VANWORMER
YN1 VINCENT P. VOIRO
YNSN PETER J. VORN BROCK
AO1 WILLIAM A. WALDRON
AD3 BILLY J. WALLACE
AW2 JOHN P. WALLSH
AN DONALD G. WALTER
AMH2 KEITH W. WARD
ADAN LANE P. WATKINS
AD1 JAMES S. WESEMAN
AW2 DAVID L. WHITE
AD1 JERRY L. WILEY
ADAN JACK G. WILKIE
PN1 ROBERT E. WILLETT
AR DENNIS J. WILLIAMS
AW2 EDWARD A. WILSON
AT2 JERRY D. WILSON
AX2 MICHAEL B. WOLFE
AX3 DAVID K. WOMACK
AZAN CARY E. WYNN
AMS1 NICK YAREMCHUK, JR.
MS2 MAXIMO M. ZARRA

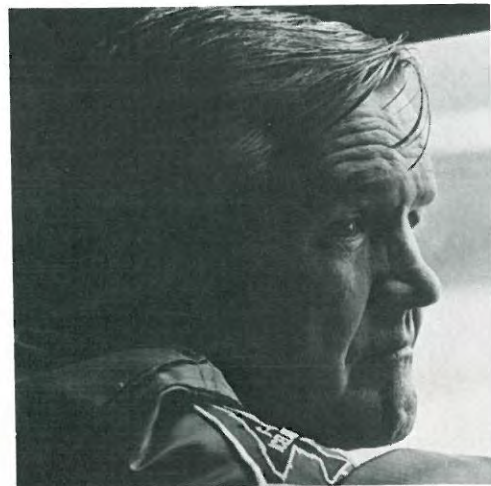
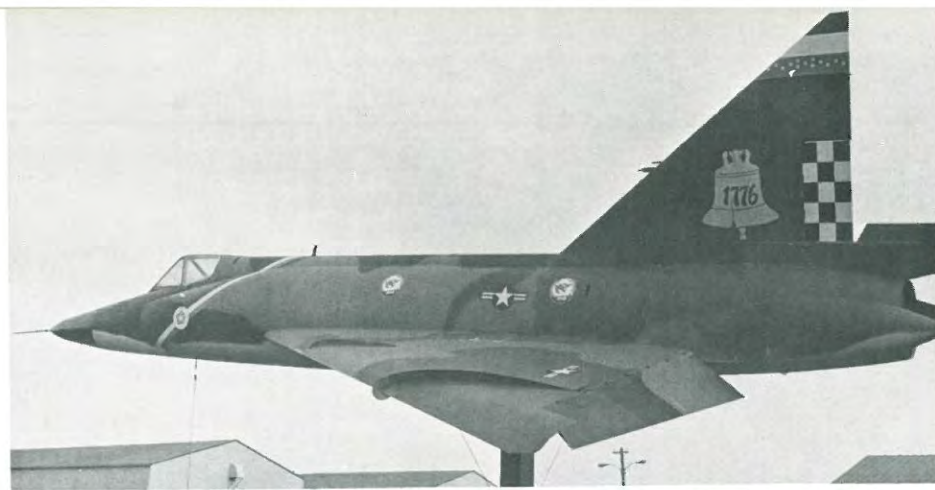

MCPOC
AFCM BERNARD R. KEMPER



**COMPATWINGSLANT
FLEET SAILOR OF THE YEAR**

AO1 JAMES E. HAYDEN, JR.

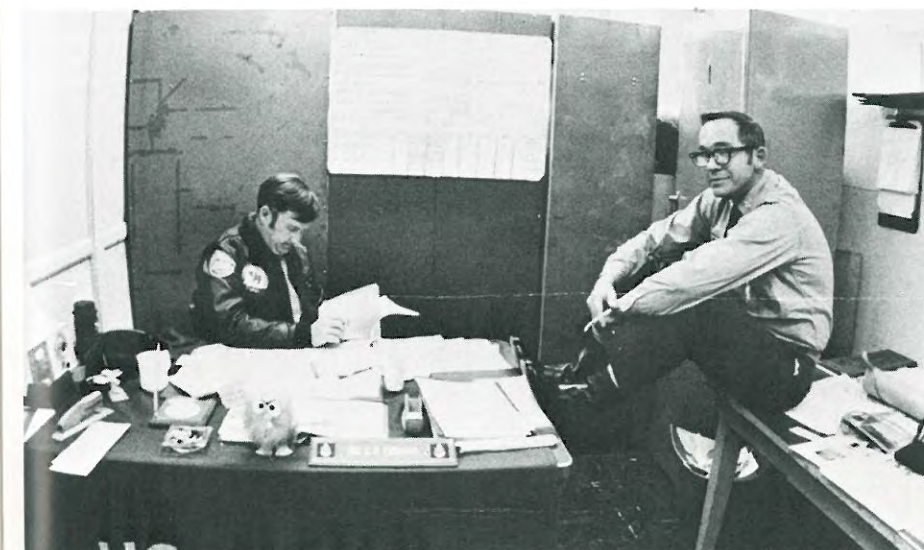
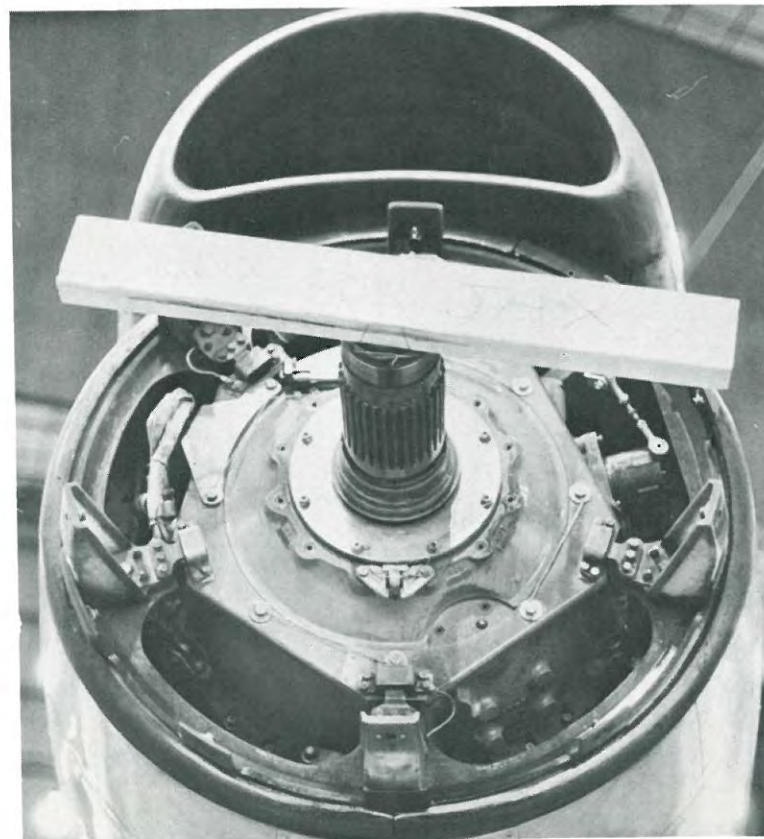
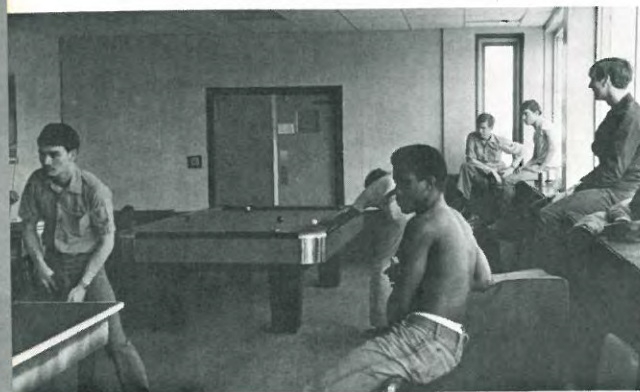

C-C/SCPOC
AXC C. D. EUBANKS AND
ATCS ED HOLT



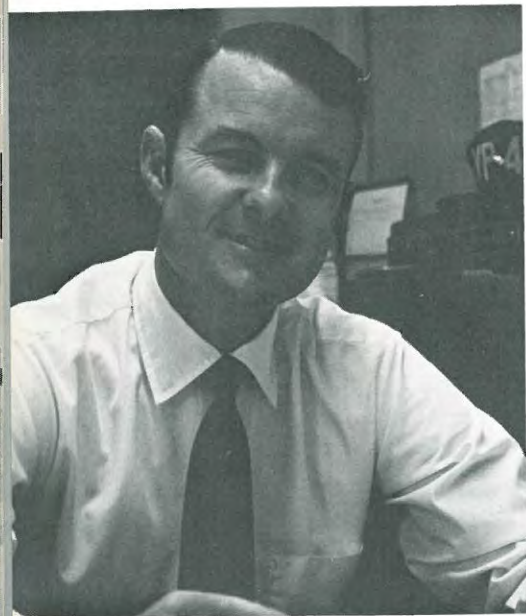

LCDR BAKER

ADMINISTRATION



LT ROBISON



LT THOMPSON AND PN3 GALLIGAN

PERSONNEL



ATCS HOLT, PR2 HARTLEY, AND PNSN HARMSEN

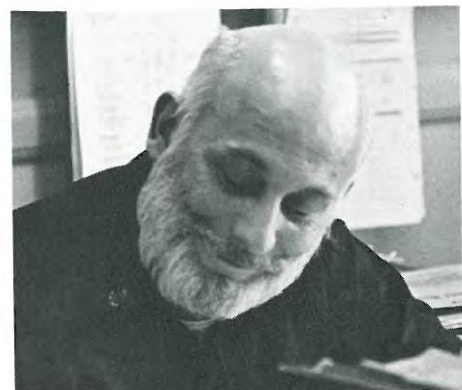

YNC HECHT



YN1 CUEVAS



LTJG BLANKENSHIP



PN3 JOHNSON



PN1 WILLETT

YN2 BERGBAUER AND YNC ACHORN

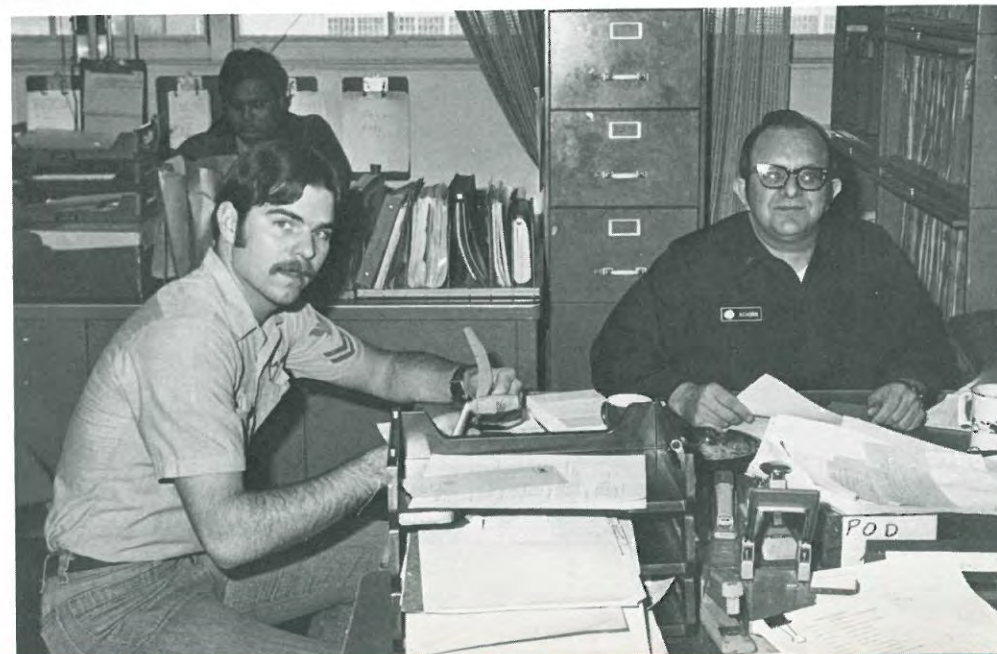

PN3 LILLOP, PNSN MCGEE AND PNSN BULLOCKS



LT WAGNER

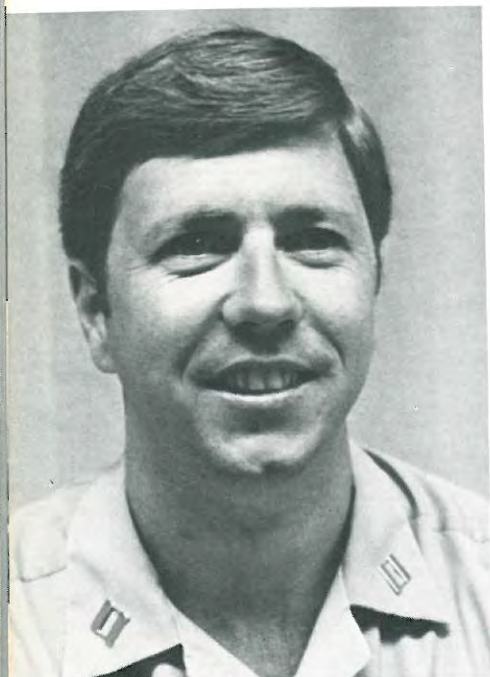

LT SHERMAN

COMM/CSM



LTJG KERNAN



AA GIROUARD AND AA REID



YN3 BRYANT, AA WILLIAMS, AN SCOTT, PN3 MULLEN, AE3 TRIBBY, PNSN BULLOCKS

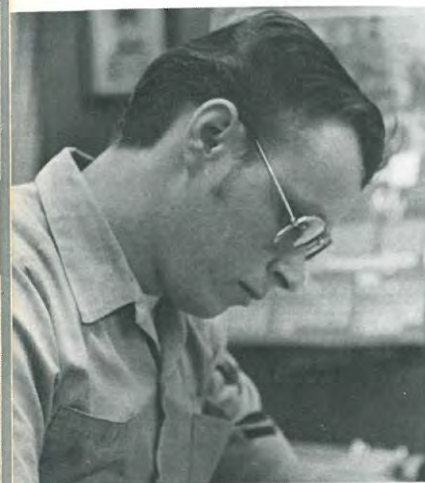

YN2 MELVIN



LT CREATH, YNSN VORNBROCK AND AWCS BABINS

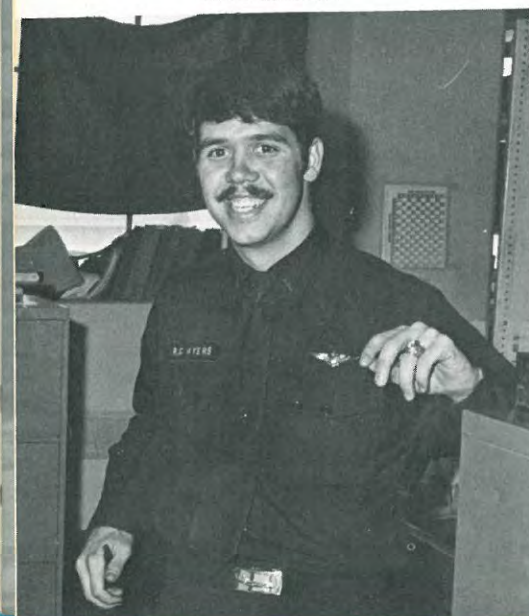

LTJG MYERS

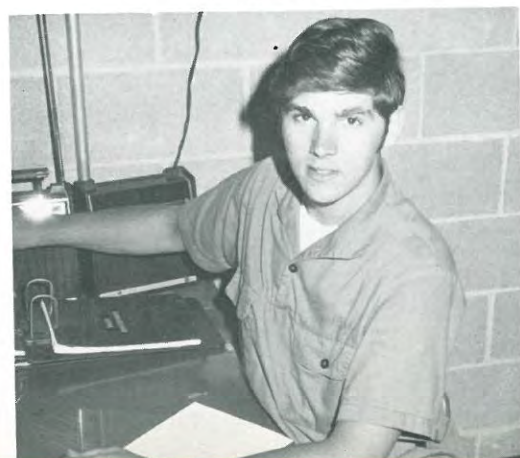

SN HUMBLE



SN NUNLEY



FIRST LIEUTENANT



MEDICAL

HM2 LEHN, LTJG MILLER AND HMC CRISP



LCDR WILSON



LCDR BENNETT



LT MARTEL



LT JOHNSON



LT WATZL



YNSN SKINNER



LT CUNNINGHAM, LTJG KINDER, FLT LT WIGHT-BOYCOTT, AWCS CHUTE AND AW1 HEMBLBY



LTJG FISHER



LT BELONCIK



LT MCCRORY

TACTICS/AIO

OPERATIONS

LTJG MCCLELLAN



LT HARDING



LT NOAK

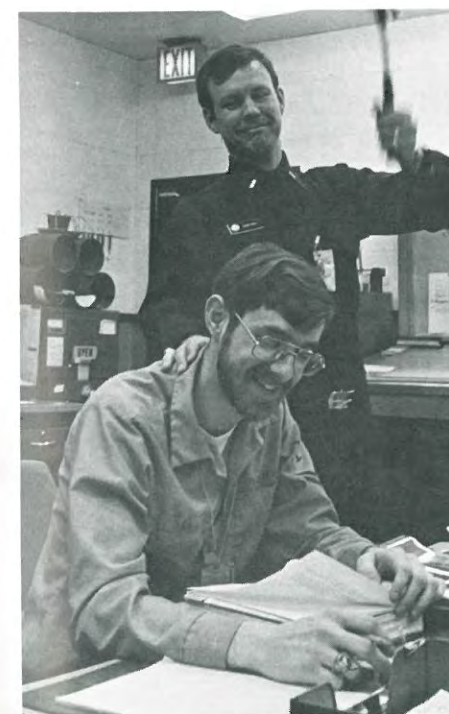
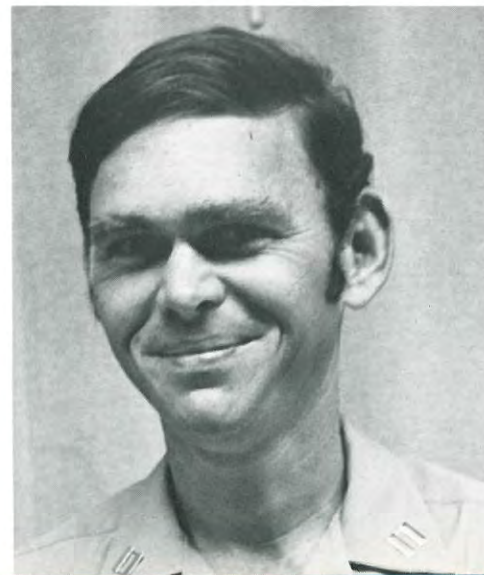

LTJG BANFORD AND IS2 PHELPS



LTJG REINHARDT



LT STIFFLER



FLT LT HALL



LT SHULER AND AO2 KEARLEY



LT ROEDER



AWC AVERY



LTJG LINGLE



AW1 CHITICK



LT STANTON



LTJG CLAUSEN



ENS TISDALE



LTJG DENMARK



ISSN BERG

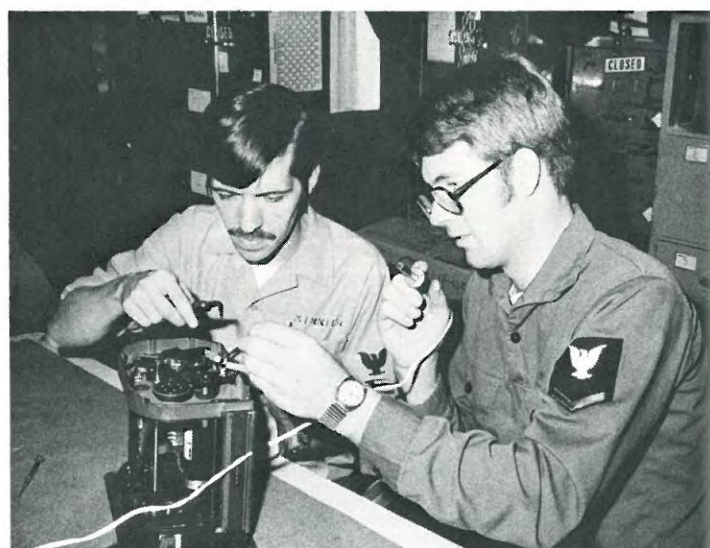

PH2 MINNICK AND PH3 CHRISTENSEN



TRAINING/AW'S



LT STANTON AND LT SCOTT



AN BRANT





LCDR DYKEMAN



CWO3 BUTLER



LT MCKINNEY



AZ1 AGEE AND AZ3 MATHIS



ATC KULIER



ATC FRANKS



ADCS RICHAU



AZ1 MCCAIG AND AZ2 TRCKA



AE3 OWENS AND AMSC STAGGS



AN BREWER



AN BARBAS

MAINTENANCE



AZAA LEE, AK3 SMITH, AZ3 MATHIS AND AMH2 WARD



ATC TANNER, LTJG RICH AND ADC FARRELL



AZC LONG



AK1 ECKERMAN



AK3 SAMUEL



AD1 KIMBRO

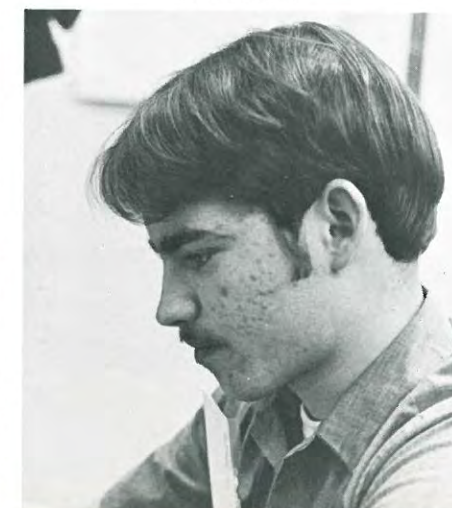

AN MEYER



AKCS OLIVER AND ENS GERTSCH

AV/EQUIPMENT

AME2 STARRITT
 AME2 KEYSOR
 PR2 HARTLEY (AIMD)
 PR2 ADKINS
 PR3 HARRIS
 AME3 CASAVANT
 AME3 KISER
 AME3 TINNEY
 PRAN VANWORMER (AIMD)



FRONT ROW: AN SARASUA, PR3 HARRIS, PR2 ADKINS, AN DENSON
 STANDING: AD2 NICELY, AMS1 YAREMCHUK, AN LEITAO, AXAN POLLARD



AD2 ORDONEZ



AD2 ELLIOTT

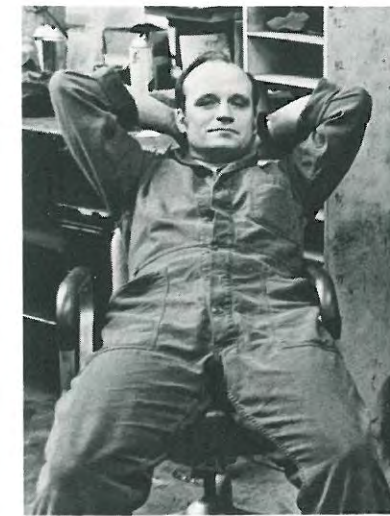

AD1 KEYLON



AD1 MISORA

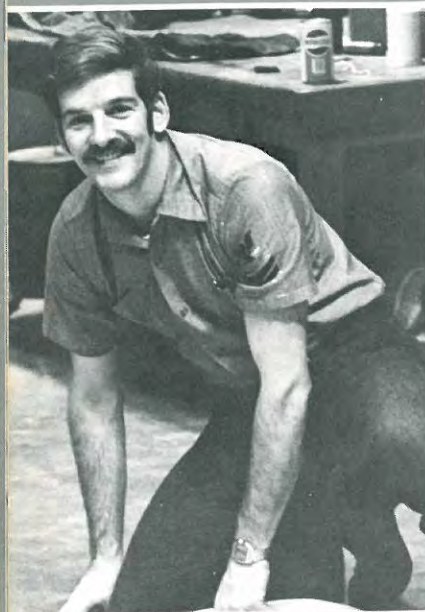

PR2 HARTLEY



PRAN VANWORMER



AME3 CASAVANT



ADAN JOHNSTON



AD1 HENSON AND AD3 GOZAR



AD3 WALLACE



AD2 NICELY



AD3 EBERSOLE AND AD2 ORDONEZ



AD2 GENTRY AND ADC HOGARTH



AD1 DAVIS



AD3 BROCKMAN



AD3 LEITAO AND AD3 MILLER

POWER PLANTS

ADC HOGARTH
 AD1 STOUT (AIMD)
 AD1 DAVIS
 AD1 HENSON
 AD1 KEYLON
 AD2 BARTON
 AD2 NICELY
 AD2 ORDONEZ
 AD2 ELLIOTT (AIMD)

AD3 EBERSOLE
 AD3 GOZAR
 AD3 WALLACE
 AD3 LEITAO
 AD3 MILLER
 AD3 BROCKMAN (AIMD)
 ADAN JOHNSTON
 ADAN PLUMMER



AX2 ICARD



SKIPPER, AX1 PELL AND RADM HEDGES



AX3 DAVIS



AX3 MEYER AND AT2 GLENN



AX2 MCCALL



AT2 STEINMETZ

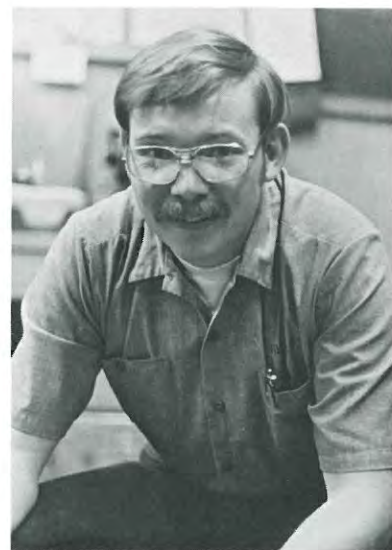

AX3 HENLEY



AX3 CORNWELL, AX2 RAPER AND AX1 PELL



AXAN CAMPBELL

AVIONICS

AXC OVERTURF
 ATC TANNER
 AX1 PELL
 AT1 DEARING
 AT1 FAUST
 AX1 KNAFFLE
 AX2 CLEMONS
 AX2 ICARD
 AX2 LANTZ
 AX2 MCCALL
 AX2 RATHER
 AT2 GLENN
 AT2 HARPER
 AX2 WOLFE (AIMD)
 AT 2 MONTGOMERY (AIMD)
 AT2 STEINMETZ (AMID)
 AX3 BUBB

AX3 CAMPBELL
 AX3 CORNWELL
 AX3 DAVIS
 AX3 EDWARDS
 AX3 GOETSCH
 AX3 HENLEY
 AX3 MEYER
 AT3 MEDCALF
 AX3 JONES
 AX3 HUBBARD (AIMD)
 AX3 WOMACK (AIMD)
 AXAN GETTEL
 AXAN POLLARD
 AXAN HULL (AIMD)
 AXAN REED (AIMD)
 ATAN HERNANDEZ (AIMD)
 ATAN TOLBERT (AIMD)



AX3 JONES



ATC TANNER, AX2 CLEMONS, AX2 LANTZ, AT1 NEAL, AX1 JARRETT AND AT1 FAUST.



AXAN HULL



AT1 DEARING



AA BARBAS, AX3 CAMPBELL, AX3 HENLEY, AXAN GETTEL

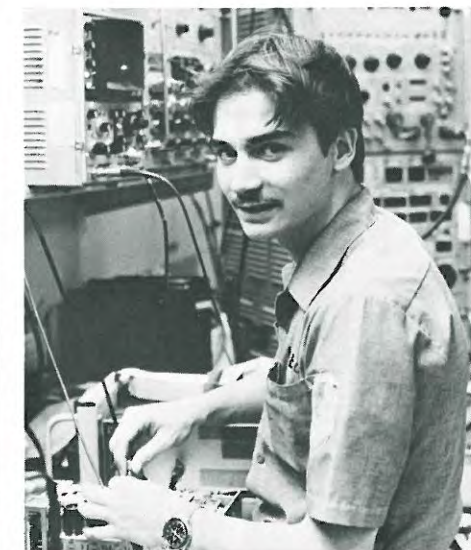

AX3 HUBBARD



AX3 BUBB

ORDNANCE

AO2 SELIG
 AO2 R. BROWN
 AO3 EDDINGS
 AOAN DENSON



STANDING: AO1 HALL, AO2 RODDAM, AOAN GREEN. KNEELING: AO2 BOGGS, AO2 FOSTER, AO2 REED

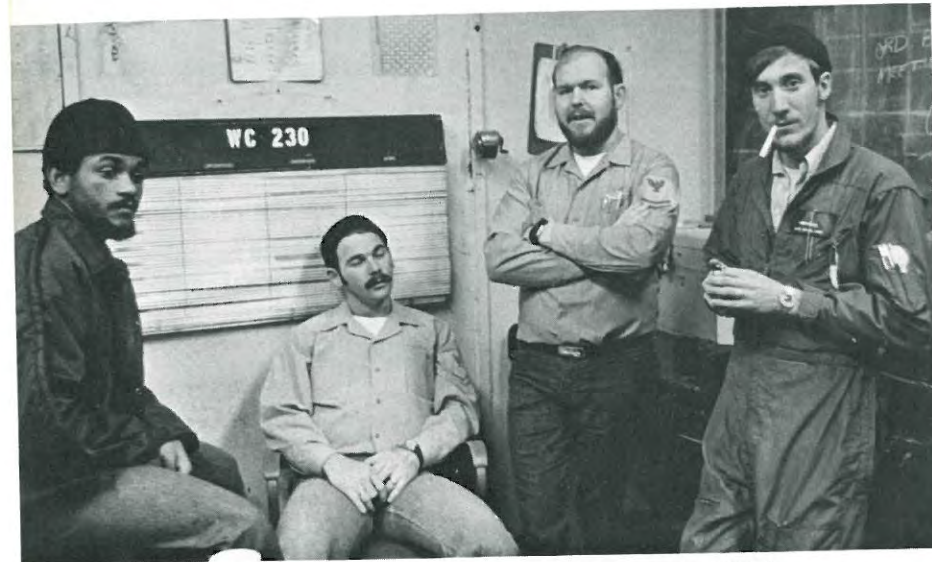

AOAN DENSON, AO2 RODDAM, AO2 J. BROWN, AO2 FOSTER



AO2 SELIG

AO2 SWILLEY

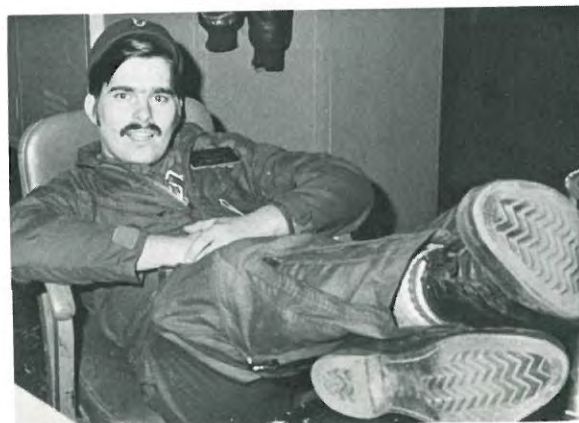

AO2 REED



FRONT ROW: AN HEAPS, ADAN WATKINS, AD3 RAWLINS, AD3 VANASSCHE, AMHAN SPARROW, ADAN POWELL, ABH1 ROULSTON, AMHAN CLARKE. STANDING: ADC HINES, LTJG WHITE, AMSAN CURYLO, ATAN KENNON, AMSAN DONNELL.



ABH1 ROULSTON



AMS3 CLARKE



LTJG DRENNAN



AMS2 CLARK

LINE

- ADC HINES
- ABH1 ROULSTON
- ASM2 TAIT
- AMS2 J.T. CLARK
- AD3 LAMBDIN
- AD3 RAWLINS
- AD3 VANASSCHE
- ABH3 BOWSER
- AMS3 J.R. CLARKE
- ASM3 BONNETTE (GSE)
- ADAN WATKINS
- ATAN KENNON
- AMSAN DONNELL
- AMSAN CURYLO
- AMHAN SPARROW
- ADAN POWELL
- AN HEAPS
- ADAN CARROLL
- AMHAN J.L. CLARK



AE1 COX



AE3 REIMER, AE3 RAY, AXC OVERTURF, AE3 IVES, LT SNYDER, AE3 OWENS



AE1 BYERS, LT FREEMAN, AD1 BYRD AND CWO2 SKINNER

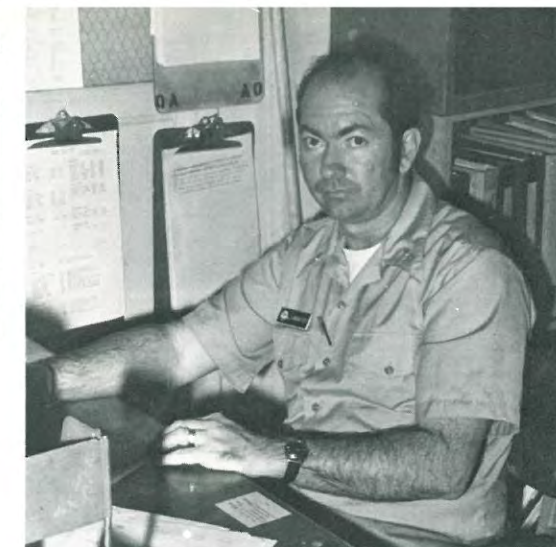

AMSC LANCASTER



AE2 AGEE



PH3 CHRISTENSEN, AE3 FRITCHMAN, AE3 TAYLOR



AE3 ERRICKSON



ADC MCGOUGH



AO1 BROWN



AZ2 HILL

ELECTRIC

AEC WILMER
 AE1 COX
 AE2 CLOYD
 AE2 ODOM
 AE2 AGEE (AIMD)
 AE2 BISHOP (AIMD)
 AE3 ERRICKSON
 AE3 FRITCHMAN

AE3 LADD
 AE3 ARY
 AE3 OWENS
 AE3 REIMER
 AE3 TAYLOR
 AE3 IVES
 AEAN PETERSON



AE2 CLOYD

AE3 FRITCHMAN, AK3 JONES, AEAN PETERSON



AE3 RAY



Q.A.

CWO2 SKINNER
 ADC MCGOUGH
 AMEC SMITH
 AMSC LANCASTER
 AO1 BROWN
 AE1 BYERS
 AD1 BYRD
 AZ2 HILL
 AMH2 WARD



CWO2 SKINNER



AMEC SMITH

AIRFRAMES

- AMS1 YAREMCHUK
- AMS1 BARLOW
- AMS2 LASTER
- AMH2 BRADFORD
- AMH2 GENERAL
- AMH2 QUINLEY
- AMH2 SMITH
- AMH2 MORAN
- AMS2 FAY
- AMS2 LEWIS
- AMS2 MATHISON
- AMS2 MCNEAL (AIMD)
- AMH2 SKELTON (AIMD)
- AMS3 BLAHA
- AMH3 HAIGHT
- AMH3 FARR
- AMH3 HEAPS
- AMS3 MUCHA
- AMS3 ALSUP
- AMHAN HAENSLEY
- AN SARASUA
- AN REID
- AN FARRELL



AMH2 QUINLEY



AMS3 BLAHA



AN SARASUA



AMH3 HEAPS



AMH3 HAIGHT AND AMS3 CLARKE



AMH3 HAIGHT, AMSAN KAMPFHENKEL, AMH3 HEAPS, AMS3 BLAHA



AN FARRELL



AMH2 MORAN



AMH2 GENERAL



AMH2 BRADFORD

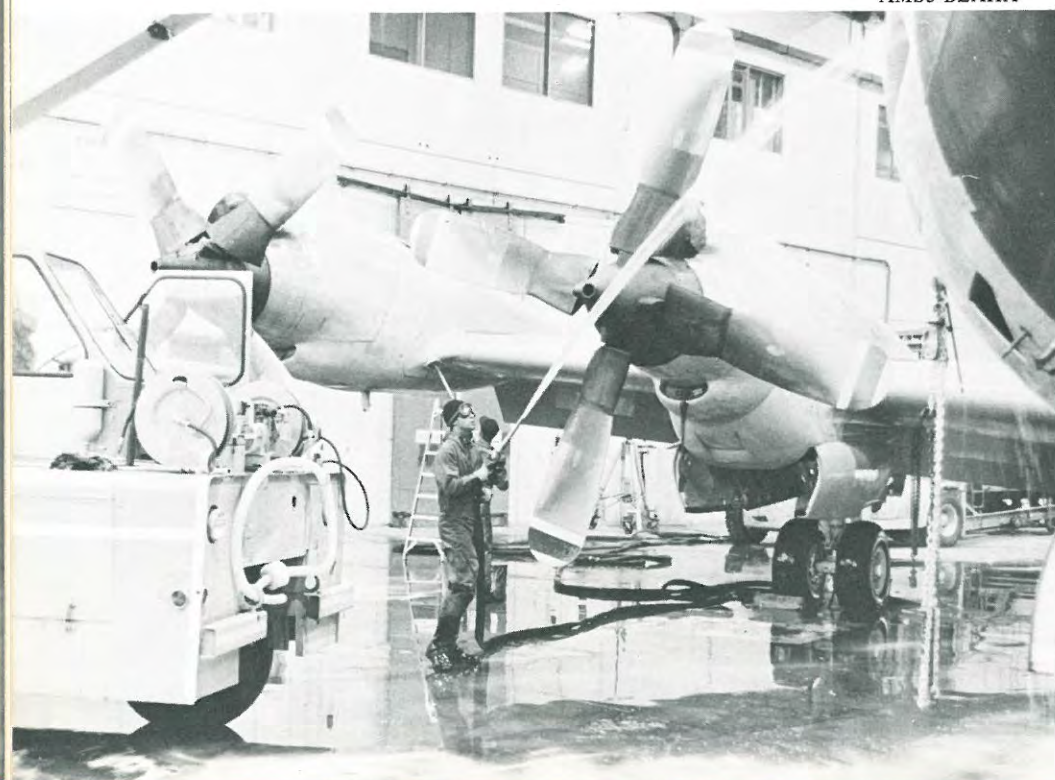

AMS2 LASTER



AMH2 SKELTON

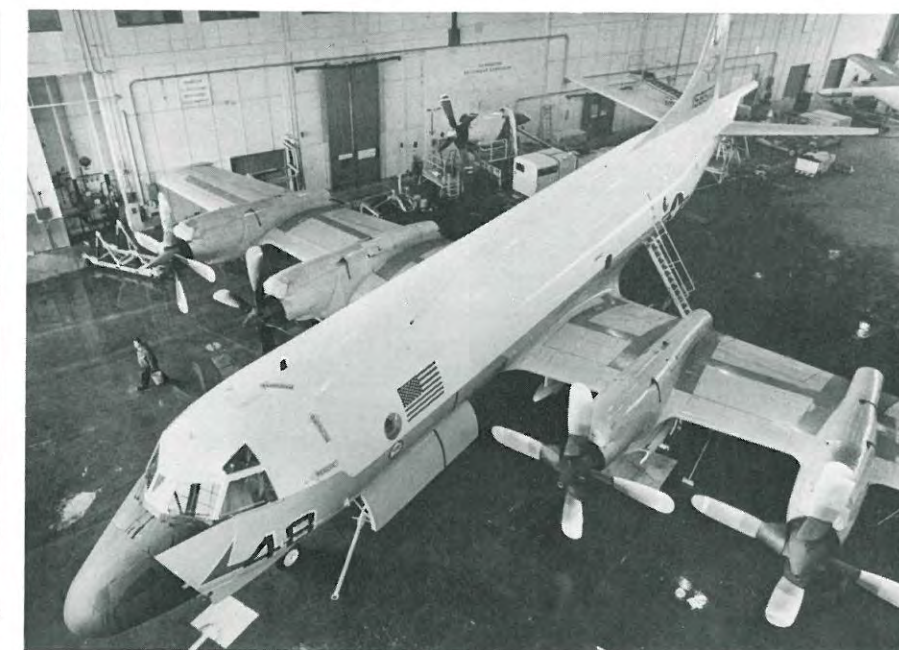

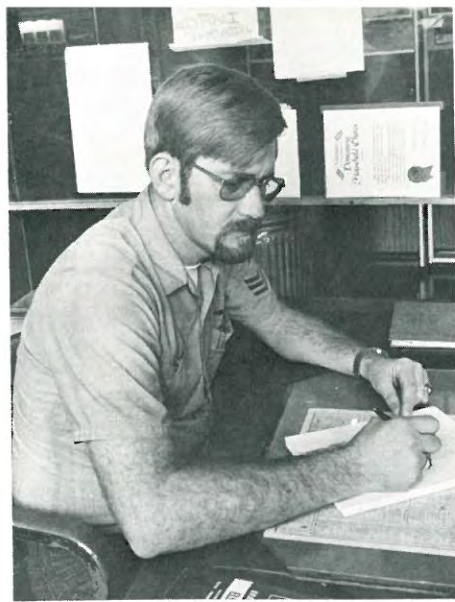

AE1 NABORS



AX2 ROBINSON



AMSAN KAMPFHENKEL



STANDING: AX2 ICARD, AE1 NABORS, AEAN LADD, YN3 MANLY, AD1 COGSWELL. KNEELING: AMHC DEARMAN, AX2 ROBINSON, YN3 RHODES, AR PATTERSON.



MS1 TUASON

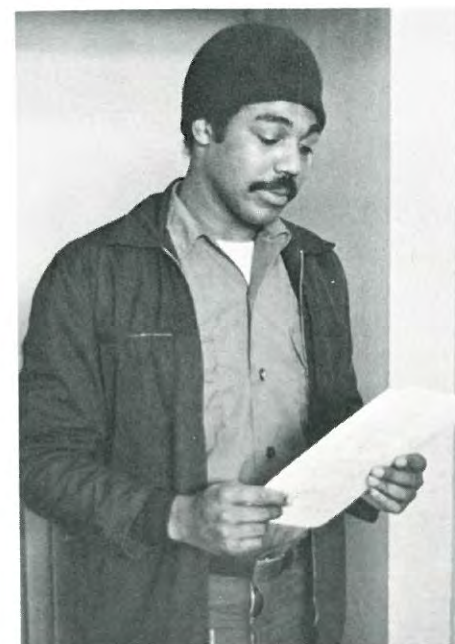

AMSAN HALL



MS3 COSCA, MS1 BUNDANG, MS3 BECKER AND MS2 RODRIGUEZ

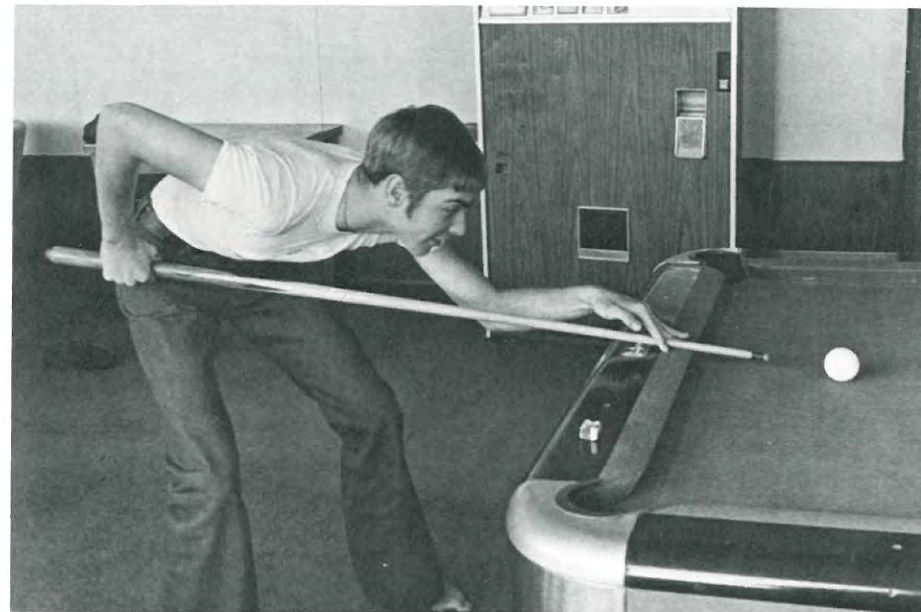

AA BLACK



MS1 CARTER



AE2 CARY



AO3 RODRIGUEZ



DK1 AGUIRRE

T.A.D.

- MS1 BUNDANG
- MS1 TUASON
- MS1 CARTER
- DK1 AGUIRRE
- AE1 NABORS
- AD1 COTTRELL
- AD1 COGSWELL
- MS2 ZARRA
- MS2 RODRIGUEZ
- PH2 HART
- PN2 FABRY
- AE2 CARY
- MS3 COSCA
- YN3 RHODES
- AMS3 BALLINGER
- ABH3 PIERSON
- AO3 RODRIGUEZ
- PHAN HOLMES
- AMSAN HALL
- MSSN BECKER
- AEAN KINDINGER
- ADAN NEISTER
- AMSAA KAMPFHENKEL
- AMSAA KEENE
- AA THIBAUT
- AMSAA STAPLETON
- AR BUNDY
- AR PATTERSON
- AR GARRETT
- AR WILLIAMS
- AR BLACK



LTJG MYERS AND LCDR MINDER-LEIN



LT BAXTER



LTJG C. D. MILLER



LCDR ELDER



AO2 JOLIS



AXC HORNING



LT OWENS



LTJG PAHA AND LTJG AYERS



LTJG BLAKE, LTJG HARMS, YNSN BARKER AND LTJG KOZIKOWSKI

YN3 MANLY

COMMAND SERVICES



LTJG KNICHEL



ENS HITE

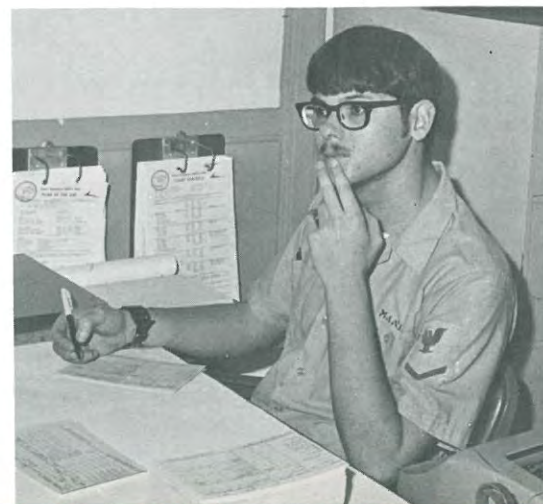

LTJG MANN



ADC POLLARD



AW1 FARY



LT MOSELEY

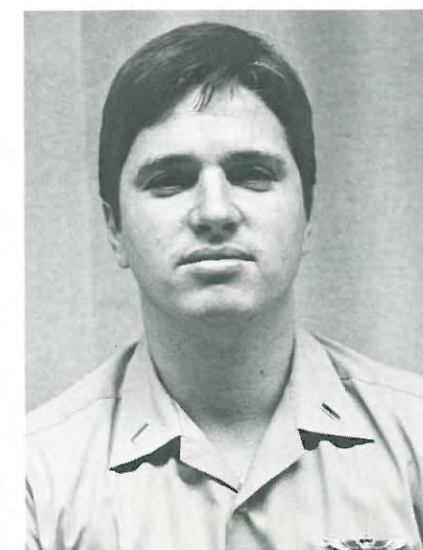

LTJG FRICK



LTJG WHITE AND LTJG KINDER

SAFETY

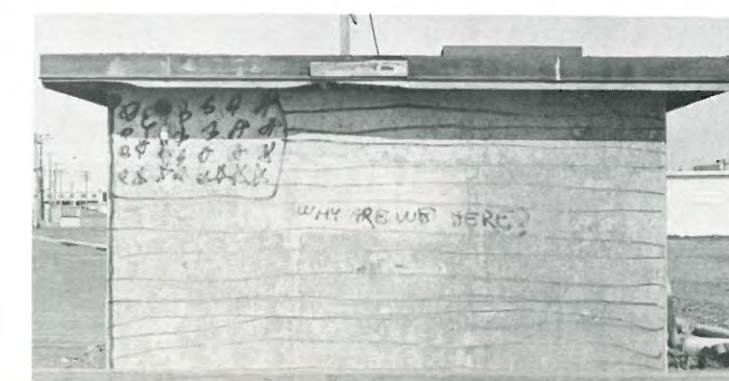
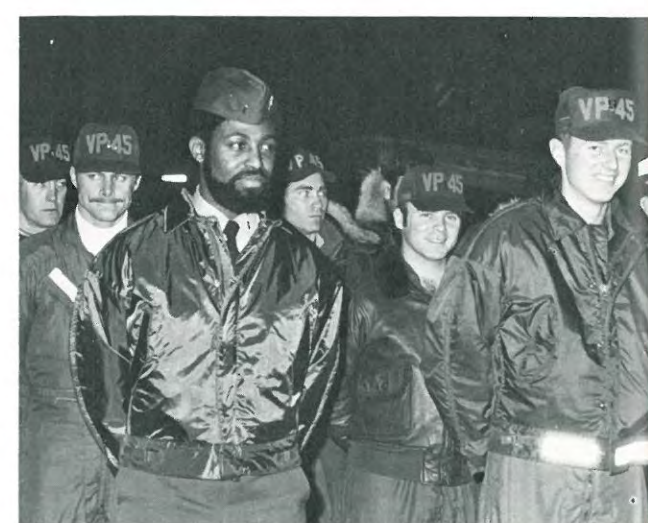
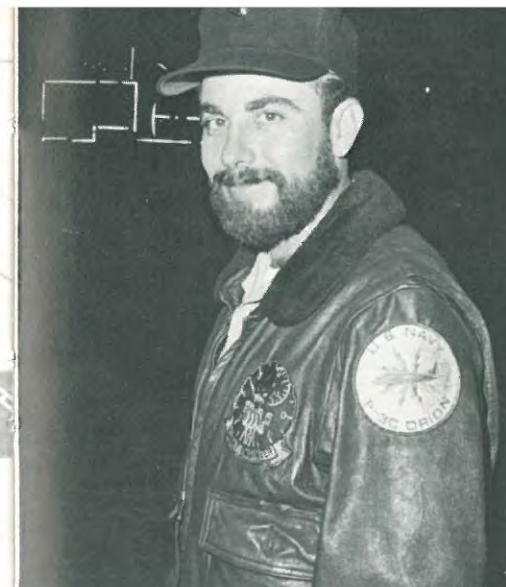



CREDITS

EDITOR:

LT RICH ROBISON

ASSISTANT:

LTJG RON AYERS

PHOTOGRAPHY:

PH2 ED MINNICK

PH2 KEN HART

AW 3 FRANK MORRIS

CONTRIBUTORS:

LTJG AL HARMS

LTJG RAY KNICHEL

LTJG ED PAHA

ENS STEVE ROSE

ENS JOE LUDWIKOWSKI

YN3 BOB MANLY

YNSN RUSS SKINNER

MRS. CHRIS ROBISON

MRS. TINA AYERS

SALES:

LT ROCKY FREEMAN

AO1 JIM "INDIAN" HAYDEN

A cruisebook historically attempts to photograph the lives and attitudes of the squadron throughout the duration of the deployment or deployments, and this staff has devoted many long, hard hours to that end. For those who have been inadvertently left out of this book, we can only say that your omission was unintentional and undesired, for you have contributed as much and have endured as long as every other man and woman in this squadron. In the end, Patrol Squadron FORTY-FIVE is only people, but damn fine people who have consistently given that extra effort over and above that which was required, often without reward or well-deserved thanks, and have made this squadron what it is. To you, we dedicate this book. We have attempted to capture and preserve a bit of that characteristic called human nature. If any idols have fallen, recruiting catalogs are always available.

R.A.R.



In the year we were supposed to have it easy
we were operational 10 out of 12 months.
From the Pacific shores of Chile to the Norwegian Sea . . .
We were there.
The airplanes flew and maintenance maintained
While the paper factory upstairs spewed forth its endless flood
Day in and day out
Work and sweat . . . counting the minutes . . . the hours . . . the days . . .
Correcting the mistakes
and learning not to make them again.

Each of us has asked himself
"Is it worth it?"
Why is it we dedicate ourselves
to the maintenance of a governmental system
that allows a disproportionate amount
of the population to enjoy or abuse
the benefits of our heritage
as it sees fit . . .

Some of us have found the answer
Some of us never will.

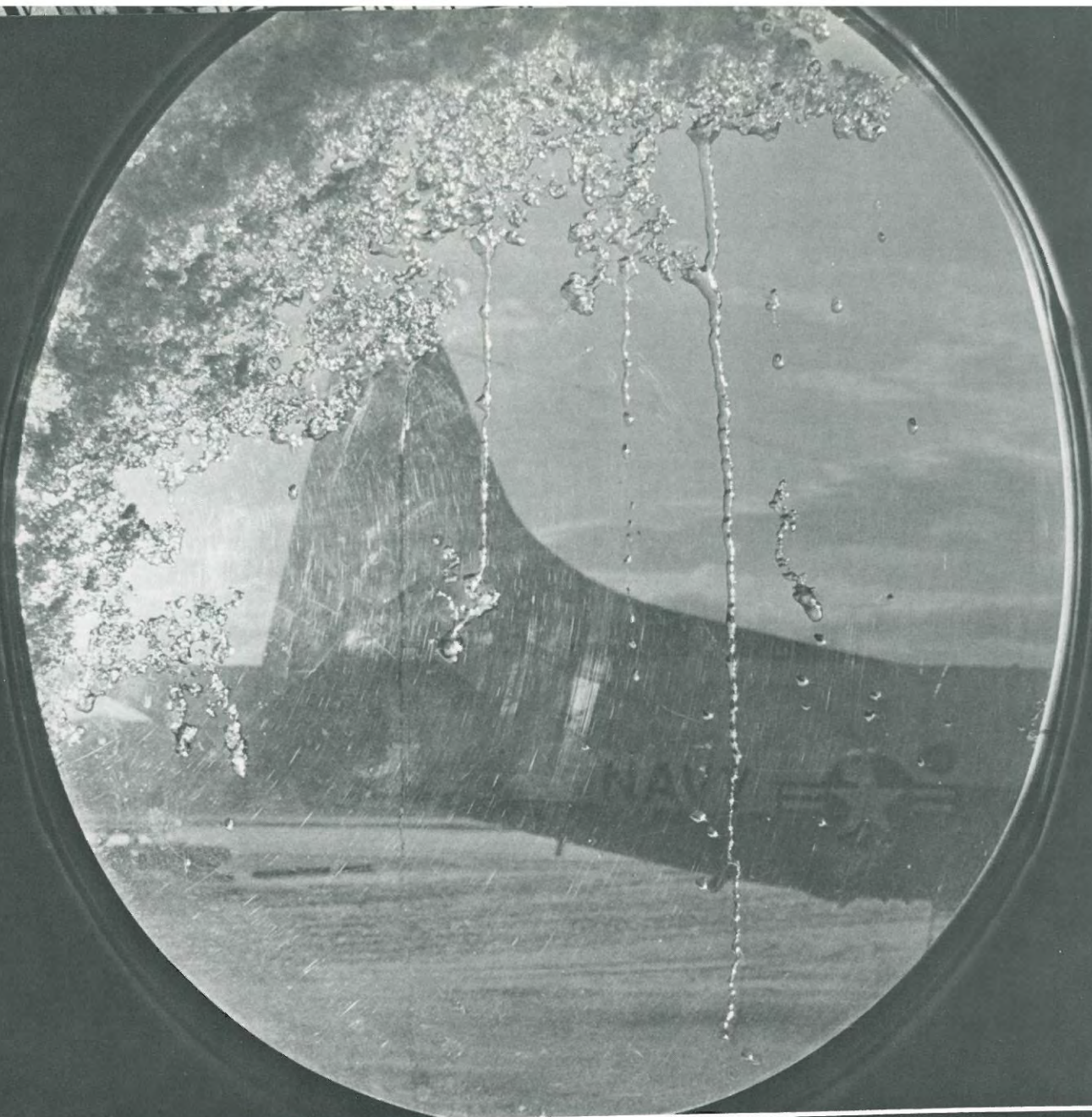

We were there.

We were Patrol Squadron FORTY-FIVE.

Four hundred individuals bound by a common goal

Freedom for all mankind.

Those who have never faced the challenge . . .

the reality . . . the loneliness

will never understand.

For who knows better the price of peace

than those who are willing to give their lives for it . . .

